

Georgia
Milestones
Assessment System



Assessment Guide
Grade 6



Assessment Guide

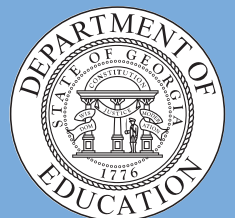

Table of Contents

THE GEORGIA MILESTONES ASSESSMENT SYSTEM	3
GEORGIA MILESTONES END-OF-GRADE (EOG) ASSESSMENTS	4
ASSESSMENT GUIDE	5
TESTING SCHEDULE	6
DEPTH OF KNOWLEDGE DESCRIPTORS	7
SCORES	10
ENGLISH LANGUAGE ARTS (ELA)	11
DESCRIPTION OF TEST FORMAT AND ORGANIZATION11
CONTENT MEASURED12
GRADE 6 ENGLISH LANGUAGE ARTS (ELA): DOMAIN STRUCTURES AND CONTENT WEIGHTS13
ITEM TYPES14
ENGLISH LANGUAGE ARTS (ELA) DEPTH OF KNOWLEDGE EXAMPLE ITEMS15
ENGLISH LANGUAGE ARTS (ELA) ADDITIONAL SAMPLE ITEMS24
ENGLISH LANGUAGE ARTS (ELA) ADDITIONAL SAMPLE ITEM KEYS38
ENGLISH LANGUAGE ARTS (ELA) EXAMPLE SCORING RUBRICS AND EXEMPLAR RESPONSES.41
ENGLISH LANGUAGE ARTS (ELA) WRITING RUBRICS45
MATHEMATICS	52
DESCRIPTION OF TEST FORMAT AND ORGANIZATION52
CONTENT MEASURED53
GRADE 6 MATHEMATICS: DOMAIN STRUCTURES AND CONTENT WEIGHTS54
ITEM TYPES55
MATHEMATICS DEPTH OF KNOWLEDGE EXAMPLE ITEMS56
MATHEMATICS ADDITIONAL SAMPLE ITEMS59
MATHEMATICS ADDITIONAL SAMPLE ITEM KEYS71
MATHEMATICS EXAMPLE SCORING RUBRICS AND EXEMPLAR RESPONSES74
APPENDIX A: LANGUAGE PROGRESSIVE SKILLS, BY GRADE	80
APPENDIX B: CONDITION CODES	81

THE GEORGIA MILESTONES ASSESSMENT SYSTEM

The purpose of the Georgia Student Assessment Program is to measure student achievement of the state-adopted content standards and inform efforts to improve teaching and learning. Results of the assessment program are utilized to identify students failing to achieve mastery of content, to provide educators with feedback about instructional practice, and to assist school districts in identifying strengths and weaknesses in order to establish priorities in planning educational programs.

The State Board of Education is required by Georgia law (O.C.G.A. §20-2-281) to adopt assessments designed to measure student achievement relative to the knowledge and skills set forth in the state-adopted content standards. The Georgia Milestones Assessment System (Georgia Milestones) fulfills this requirement and, as a key component of Georgia's Student Assessment Program, is a comprehensive summative assessment program spanning grade 3 through high school. Georgia Milestones measures how well students have learned the knowledge and skills outlined in the state-adopted content standards in Language Arts, Mathematics, Science, and Social Studies. Students in grades 3 through 8 take an end-of-grade assessment in English Language Arts and Mathematics, while students in grades 5 and 8 also take an end-of-grade assessment in Science and Social Studies. High school students take an end-of-course assessment for each of the ten courses designated by the State Board of Education. In accordance with State Board Rule, Georgia Milestones end-of-course measures serve as the final exams for the specified high school courses.

The main purpose of Georgia Milestones is to inform efforts to improve student achievement by assessing student performance on the standards specific to each course or subject/grade tested. Specifically, Georgia Milestones is designed to provide students and their parents with critical information about the students' achievement and, importantly, their preparedness for the next educational level. The assessment system is a critical informant of the state's accountability measure, the College and Career Ready Performance Index (CCRPI), providing an important gauge about the quality of the educational services and opportunities provided throughout the state. The ultimate goal of Georgia's assessment and accountability system is to ensure that all students are provided the opportunity to engage with high-quality content standards, receive high-quality instruction predicated upon those standards, and are positioned to meet high academic expectations.

Features of the Georgia Milestones Assessment System include:

- technology-enhanced items in English Language Arts and Mathematics (all grades and courses);
- open-ended (constructed-response) items in English Language Arts and Mathematics (all grades and courses);
- a writing component (in response to passages read by students) at every grade level and course within the English Language Arts assessment;
- norm-referenced items in all content areas and courses to complement the criterion-referenced information and to provide a national comparison; and

- a transition to online administration over time, with online administration considered the primary mode of administration and paper/pencil as a backup until the transition is complete.

The primary mode of administration for the Georgia Milestones program is online, with the goal of completing the transition from paper/pencil within five years after the inaugural administration (i.e., the 2014–2015 school year). Paper/pencil test materials (such as Braille) will remain available for students with disabilities who may require them in order to access the assessment.

Georgia Milestones follows guiding principles to help ensure that the assessment system:

- is sufficiently challenging to ensure Georgia students are well positioned to compete with other students across the United States and internationally;
- is intentionally designed across grade levels to send a clear signal of student academic progress and preparedness for the next level, whether it is the next grade level, course, or college or career;
- is accessible to all students, including those with disabilities or limited English proficiency, at all achievement levels;
- supports and informs the state’s educator-effectiveness initiatives, ensuring items and forms are appropriately sensitive to quality instructional practices; and
- accelerates the transition to online administration, allowing—over time—for the inclusion of innovative technology-enhanced items.

GEORGIA MILESTONES END-OF-GRADE (EOG) ASSESSMENTS

As previously mentioned, Georgia law (§20-2-281) mandates that the State Board of Education adopt annual measures of student achievement in the content areas of English Language Arts (ELA) and Mathematics in grades 3–8 and Science and Social Studies in grades 5 and 8. Students must participate in the Georgia Milestones content areas measured at the end of each grade in which they are enrolled. State law further mandates that student achievement in reading, as measured as a component of the Georgia Milestones English Language Arts (ELA) EOG assessment, be utilized in promotion and retention decisions for students in grades 3, 5, and 8, while student achievement in mathematics, as measured by the Georgia Milestones Mathematics EOG assessment, be considered in grades 5 and 8. Students who fail to demonstrate grade-level achievement on these measures must receive remediation and be offered an opportunity for a retest prior to consideration for promotion to grades 4, 6, and 9 (§20-2-283 and State Board of Education Rule 160-4-2-.11).

Results of the EOG assessments, according to the legislated and identified purposes, must:

- provide a valid measure of student achievement of the state content standards across the full achievement continuum;
- provide a clear signal of each student’s preparedness for the next educational level (i.e., grade);
- allow for the detection of the academic progress made by each student from one assessed grade to the next;
- be suitable for use in promotion and retention decisions at grades 3 (reading), 5 (reading and mathematics), and 8 (reading and mathematics);
- support and inform educator-effectiveness measures; and

- inform state and federal accountability measures at the school, district, and state levels.

ASSESSMENT GUIDE

The Georgia Milestones Grade 6 EOG Assessment Guide is provided to acquaint Georgia educators and other stakeholders with the structure and content assessed by the tests. Importantly, this guide is not intended to inform instructional planning. It is essential to note that there are a small number of content standards that are better suited for classroom or individual assessment rather than large-scale summative assessment. While those standards are not included on the tests, and therefore are not included in this Assessment Guide, the knowledge, concepts, and skills inherent in those standards are often required for the mastery of the standards that are assessed. Failure to attend to all content standards within a content area can limit a student's opportunity to learn and show what he or she knows and can do on the assessments.

The Georgia Milestones Grade 6 EOG Assessment Guide is in *no way* intended to substitute for the state-mandated content standards; it is provided to help educators better understand the structure and content of the assessments, *but is not all-encompassing of the knowledge, concepts, and skills covered in Grade 6 or assessed on the tests*. The state-adopted content standards and associated standards-based instructional resources, such as the Content Frameworks, should be used to plan instruction. This Assessment Guide can serve as a *supplement* to those resources, in addition to any locally developed resources, **but should not be used in isolation**. In principle, this Assessment Guide is intended to be descriptive of the assessment program and should not be considered all-inclusive. The state-adopted content standards are located at www.georgiastandards.org.

TESTING SCHEDULE

The Georgia Milestones Grade 6 EOG assessment is offered during the Main Administration each spring and one Summer Administration for retests.

Students will take the Georgia Milestones Grade 6 EOG assessment on days specified by their local school district during the testing window. Each district determines a local testing window within the state-designated testing window.

DEPTH OF KNOWLEDGE DESCRIPTORS

Items found on the Georgia Milestones assessments, including the Grade 6 EOG assessment, are developed with a particular emphasis on cognitive complexity, or Depth of Knowledge (DOK). DOK is measured on a scale of 1 to 4 and refers to the level of cognitive demand required to complete a task (or in this case, an assessment item). The higher the level, the *more complex* the assessment; however, higher levels do not necessarily mean *more difficult* items. For instance, a question can have a low DOK but a medium or even high difficulty level. Conversely, a DOK 4 question may have a low difficulty level but still require a great deal of cognitive thinking (e.g., analyzing and synthesizing information instead of just recalling it). The following descriptions and table show the expectations of the four DOK levels in greater detail.

Level 1 (Recall of Information) generally requires students to identify, list, or define, often asking them to recall who, what, when, and where. Consequently, this level usually asks students to recall facts, terms, concepts, and trends and may ask them to identify specific information contained in documents, excerpts, quotations, maps, charts, tables, graphs, or illustrations. Items that require students to “describe” and/or “explain” could be classified at Level 1 or Level 2, depending on what is to be described and/or explained. A Level 1 “describe” and/or “explain” would require students to recall, recite, or reproduce information.

Level 2 (Basic Reasoning) includes the engagement of some mental processing beyond recalling or reproducing a response. A Level 2 “describe” and/or “explain” would require students to go beyond a description or explanation of recalled information to describe and/or explain a result or “how” or “why.”

Level 3 (Complex Reasoning) requires reasoning, using evidence, and thinking on a higher and more abstract level than Level 1 and Level 2. Students will go beyond explaining or describing “how and why” to justifying the “how and why” through application and evidence. Level 3 questions often involve making connections across time and place to explain a concept or “big idea.”

Level 4 (Extended Reasoning) requires the complex reasoning of Level 3 with the addition of planning, investigating, applying significant conceptual understanding, and/or developing that will most likely require an extended period of time. Students should be required to connect and relate ideas and concepts *within* the content area or *among* content areas in order to be at this highest level. The distinguishing factor for Level 4 would be evidence (through a task, a product, or an extended response) that the cognitive demands have been met.

The following table identifies skills that students will need to demonstrate at each DOK level, along with sample question cues appropriate for each level.

Level	Skills Demonstrated	Question Cues
<p style="text-align: center;">Level 1 Recall of Information</p>	<ul style="list-style-type: none"> • Make observations • Recall information • Recognize formulas, properties, patterns, processes • Know vocabulary, definitions • Know basic concepts • Perform one-step processes • Translate from one representation to another • Identify relationships 	<ul style="list-style-type: none"> • Tell what, when, or where • Find • List • Define • Identify; label; name • Choose; select • Compute; estimate • Express as • Read from data displays • Order
<p style="text-align: center;">Level 2 Basic Reasoning</p>	<ul style="list-style-type: none"> • Apply learned information to abstract and real-life situations • Use methods, concepts, theories in abstract and real-life situations • Perform multi-step processes • Solve problems using required skills or knowledge (requires more than habitual response) • Make a decision about how to proceed • Identify and organize components of a whole • Extend patterns • Identify/describe cause and effect • Recognize unstated assumptions; make inferences • Interpret facts • Compare or contrast simple concepts/ideas 	<ul style="list-style-type: none"> • Apply • Calculate; solve • Complete • Describe • Explain how; demonstrate • Construct data displays • Construct; draw • Analyze • Extend • Connect • Classify • Arrange • Compare; contrast

Level	Skills Demonstrated	Question Cues
<p style="text-align: center;">Level 3 Complex Reasoning</p>	<ul style="list-style-type: none"> • Solve an open-ended problem with more than one correct answer • Create a pattern • Generalize from given facts • Relate knowledge from several sources • Draw conclusions • Make predictions • Translate knowledge into new contexts • Compare and discriminate between ideas • Assess value of methods, concepts, theories, processes, formulas • Make choices based on a reasoned argument • Verify the value of evidence, information, numbers, data 	<ul style="list-style-type: none"> • Plan; prepare • Predict • Create; design • Ask “what if?” questions • Generalize • Justify; explain why; support; convince • Assess • Rank; grade • Test; judge • Recommend • Select • Conclude
<p style="text-align: center;">Level 4 Extended Reasoning</p>	<ul style="list-style-type: none"> • Analyze and synthesize information from multiple sources • Examine and explain alternative perspectives across a variety of sources • Describe and illustrate how common themes are found across texts from different cultures • Apply mathematical models to illuminate a problem or situation • Design a mathematical model to inform and solve a practical or abstract situation • Combine and synthesize ideas into new concepts 	<ul style="list-style-type: none"> • Design • Connect • Synthesize • Apply concepts • Critique • Analyze • Create • Prove

SCORES

Students will receive a scale score and an Achievement Level designation based on total test performance. In addition, students will receive information on how well they performed at the domain level. Students will also receive a norm-referenced score based on a set of norm-referenced items included within the test; this score will allow comparison to a national norming group of students. Additional information on the items contributing to these scores is found in the Description of Test Format and Organization sections for English Language Arts (ELA) and Mathematics.

Selected-response items and technology-enhanced items are machine scored. The English Language Arts (ELA) assessment consists of a variety of item types that contribute to the student's score, including selected-response, technology-enhanced, constructed-response, extended constructed-response, and extended writing-response. Likewise, the Mathematics assessment consists of selected-response, technology-enhanced, constructed-response, and extended constructed-response items. Items that are not machine scored—i.e., constructed-response, extended constructed-response, and extended writing-response items—require rubrics for manual scoring.

ENGLISH LANGUAGE ARTS (ELA)

DESCRIPTION OF TEST FORMAT AND ORGANIZATION

The Georgia Milestones English Language Arts (ELA) EOG assessment is primarily a criterion-referenced test, designed to provide information about how well a student has mastered the grade-level state-adopted content standards in English Language Arts (ELA). Each student will receive one of four Achievement Level designations, depending on how well the student has mastered the content standards. The four Achievement Level designations are Beginning Learner, Developing Learner, Proficient Learner, and Distinguished Learner. In addition to criterion-referenced information, the Georgia Milestones measures will also include a limited sample of nationally norm-referenced items to provide a signal of how Georgia students are achieving relative to their peers nationally. The norm-referenced information provided is supplementary to the criterion-referenced Achievement Level designation and will not be utilized in any manner other than to serve as a barometer of national comparison. Only the criterion-referenced scores and Achievement Level designations will be utilized in the accountability metrics associated with the assessment program (such as student growth measures, educator-effectiveness measures, or the CCRPI).

The Grade 6 English Language Arts EOG assessment consists of both operational items (contribute to a student's criterion-referenced and/or norm-referenced score) and field test items (newly written items that are being tried out and do not contribute to the student's score). A subset of the norm-referenced operational items have been verified as aligned to the course content standards by Georgia educators and will also contribute to the criterion-referenced score and Achievement Level designation. The other norm-referenced items will contribute only to the national percentile rank, which is provided as supplemental information.

With the inclusion of the norm-referenced items, students may encounter items for which they have not received direct instruction. These items will not contribute to the students' criterion-referenced Achievement Level designation; only items that align to the course content standards will contribute to the criterion-referenced score. Students should be instructed to try their best should they ask about an item that is not aligned to the content they have learned as part of the course.

The table on the following page outlines the number and types of items included on the Grade 6 English Language Arts EOG assessment.

Grade 6 English Language Arts (ELA) EOG Assessment Design

Description	Number of Items	Points for CR ¹ Score	Points for NRT ² Feedback
CR Selected-Response Items	28	28	0
NRT Selected-Response Items	20 ³	10 ⁴	20
CR Technology-Enhanced Items	1	2	0
CR Constructed-Response Items	2	4	0
CR Extended Constructed-Response Items	1	4	0
CR Extended Writing-Response Items	1	7	0
CR Field Test Items	7	0	0
Total Items/Points⁵	60	55	20

¹CR—Criterion-Referenced: items aligned to state-adopted content standards

²NRT—Norm-Referenced Test: items that will yield a national comparison; may or may not be aligned to state-adopted content standards

³Of these items, approximately 10 will contribute to both the CR scores and NRT feedback. The other 10 of these items will contribute to NRT feedback only and will not impact the student's Achievement Level designation, scale score, or grade conversion.

⁴Alignment of national NRT items to course content standards was verified by a committee of Georgia educators. Only approved, aligned NRT items will contribute to a student's CR Achievement Level designation, scale score, and grade conversion score.

⁵Of the 60 total items, 43 items contribute to the CR score, for a total of 55 points; 20 total items contribute to NRT feedback, for a total of 20 points.

The test will be given in three sections. Students will be given a maximum of 90 minutes to complete Section 1, which includes the extended writing response.* Students may have up to 75 minutes per section to complete Sections 2 and 3. The total estimated testing time for the Grade 6 English Language Arts (ELA) EOG assessment ranges from approximately 190 to 240 minutes. Total testing time describes the amount of time students have to complete the assessment. It does not take into account the time required for the test examiner to complete pre-administration and post-administration activities (such as reading the standardized directions to students). Section 1, which focuses on writing, must be administered on a separate day. Sections 2 and 3 must be scheduled such that both will be completed in a single day or over the course of two consecutive days (one section each day) and should be completed within the same week following the district's testing protocols for the EOG measures (in keeping with state guidance).

CONTENT MEASURED

The Grade 6 English Language Arts (ELA) assessment will measure the Grade 6 standards that are described at www.georgiastandards.org.

* Beginning with the Spring 2017 administration, the extended writing-response will appear in Section 1. Prior to Spring 2017, the extended writing-response appears in Section 3.

The content of the assessment is organized into two groupings, or domains, of standards for the purposes of providing feedback on student performance. A content domain is a reporting category that *broadly* describes and defines the content of the course, as measured by the EOG assessment. The standards for Grade 6 English Language Arts (ELA) are grouped into two domains: Reading and Vocabulary, and Writing and Language. Each domain was created by organizing standards that share similar content characteristics. The content standards describe the level of expertise that Grade 6 English Language Arts (ELA) educators should strive to develop in their students. Educators should refer to the content standards for a full understanding of the knowledge, concepts, and skills subject to be assessed on the EOG assessment.

The approximate proportional number of points associated with each domain is shown in the following table. A range of cognitive levels will be represented on the Grade 6 English Language Arts (ELA) EOG assessment. Educators should always use the content standards when planning instruction.

GRADE 6 ENGLISH LANGUAGE ARTS (ELA): DOMAIN STRUCTURES AND CONTENT WEIGHTS

Domain	Standard	Approximate Weight	
Reading and Vocabulary	ELAGSE6RI1	ELAGSE6RL2	53%
	ELAGSE6RI2	ELAGSE6RL3	
	ELAGSE6RI3	ELAGSE6RL4	
	ELAGSE6RI4	ELAGSE6RL5	
	ELAGSE6RI5	ELAGSE6RL6	
	ELAGSE6RI6	ELAGSE6RL9	
	ELAGSE6RI7	ELAGSE6L4	
	ELAGSE6RI8	(4a, 4b, 4c)	
	ELAGSE6RI9	ELAGSE6L5	
	ELAGSE6RL1	(5a, 5b, 5c)	
Writing and Language	ELAGSE6W1 (1a, 1b, 1c, 1d, 1e)	ELAGSE6W8 ELAGSE6W9	47%
	ELAGSE6W2 (2a, 2b, 2c, 2d, 2e, 2f)	ELAGSE6L1 (1a, 1b, 1c, 1d, 1e)	
	ELAGSE6W3 (3a, 3b, 3c, 3d, 3e)	ELAGSE6L2 (2a, 2b)	
	ELAGSE6W4	ELAGSE6L3	
	ELAGSE6W7	(3a, 3b)	

ITEM TYPES

The English Language Arts (ELA) portion of the Grade 6 EOG assessment consists of selected-response, technology-enhanced, constructed-response, extended constructed-response, and extended writing-response items.

A selected-response item, sometimes called a multiple-choice item, is defined as a question, problem, or statement that appears on a test followed by several answer choices, sometimes called options or response choices. The incorrect choices, called distractors, usually reflect common errors. The student's task is to choose, from the alternatives provided, the best answer to the question posed in the stem (the question). The English Language Arts (ELA) selected-response items will have four answer choices.

A technology-enhanced item is an innovative way to measure student skills and knowledge using scaffolding within a multi-step response. For ELA, the specific type of technology-enhanced item being used is a two-part item called an Evidence-Based Selected Response item (EBSR). In the first part of an EBSR item, the student responds to an inferential or key concept question related to a stimulus text. In the second part of an EBSR item, the student provides evidence from the same text to support the inference or idea. In both parts of an EBSR item, the student selects the responses from the choices provided. In the first part, there is one correct answer. In the second part, the student will be asked to choose one correct response or the student will be asked to choose one or more correct responses. If the student responds correctly to both parts of the EBSR item, the student receives two points. Partial credit may be awarded when a student answers the first part correctly.

A constructed-response item asks a question and solicits the student to provide a response he or she constructs on his or her own, as opposed to selecting from options provided. The constructed-response items on the EOG assessment will be worth two points. Partial credit may be awarded if part of the response is correct.

An extended constructed-response item is a specific type of constructed-response item that elicits a longer, more detailed response from the student than a two-point constructed-response item. The extended constructed-response items on the EOG assessment will be worth four points. For English Language Arts (ELA), the student will respond to a narrative prompt based on a passage the student has read, and the response will be scored for the Writing and Language domain. Partial credit may be awarded if part of the response is correct.

The extended writing-response items require students to produce arguments or develop an informative response. As part of the extended writing task, students must first read two passages and then respond to three multiple-choice items and one constructed-response item. All of these items help students write their extended essay by focusing them on the main idea(s) and key details in the passages. Two of the selected-response items will address each of the passages separately. One selected-response item and the constructed-response item will address both of the passages together. All four items contribute to the Reading and Vocabulary domain. These items will be followed by an extended writing-prompt, which requires the student to draw from reading experiences when writing an essay response and to cite evidence from the passage(s) to support claims and conclusions in the essay. The writing task is worth seven points.

ENGLISH LANGUAGE ARTS (ELA) DEPTH OF KNOWLEDGE EXAMPLE ITEMS

Example items that represent the applicable DOK levels across various Grade 6 English Language Arts (ELA) content domains are provided.

All example and sample items contained in this guide are the property of the Georgia Department of Education.

Example Items 1 and 2

Read the article “The Hermit Crab” and answer example Items 1 and 2.

The Hermit Crab

The word *hermit* is used to describe someone or something that lives alone. In the case of the hermit crab, however, nothing could be further from the truth! Though each hermit crab has its own shell, hermit crabs like to socialize and live in packs.

One of the many interesting things about the hermit crab is its body, which is segmented. This means that the hermit crab’s body has different parts, like an insect’s body, rather than one part, like a snake’s body.

The front half of the hermit crab’s body is covered in an exoskeleton, or hard outer skin.

The lower half of the hermit crab’s body is not covered with an exoskeleton. Thus, it is more fragile than the other parts of the crab’s body. The only protection for this soft part of its body is its shell. However, hermit crabs are not born with shells. They spend a great deal of time searching for abandoned shells that they can squeeze into. The hermit crab keeps its shell until it grows too large for it. Then it leaves to go find another. Though hermit crabs are very particular, they often select objects other than shells to crawl into. For example, they have been known to crawl into small cans.

The hermit crab has two front claws that are different sizes and have different purposes. The left claw is large and is used to defend the crab against predators. This claw can also be used to grab objects or to balance when the crab is using its other claw. The right claw is smaller than the left and is used to grasp food.

When the hermit crab searches for food, it uses its antennae to smell and taste. The antennae are also used to feel objects. The hermit crab can see in many different directions with its compound eyes. Compound means the eyes have many lenses. The eyes stick out from the rest of the hermit crab’s body because they are at the end of a long body part called an eyestalk.

The Underside of a Hermit Crab without Its Shell

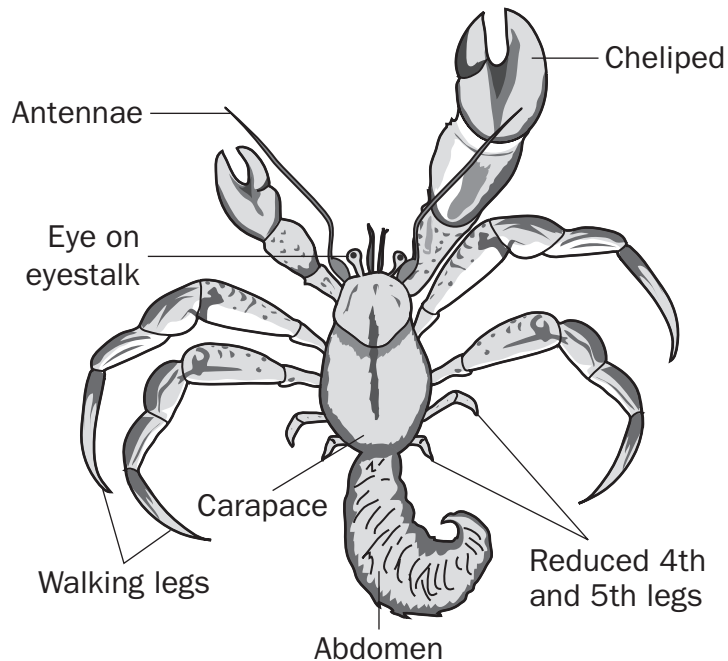

Though the hermit crab is selective about its shell, it is not picky when it comes to the type of food it will eat. The hermit crab tends to eat anything that is lying around. It will eat algae, sea plants, fish, and vegetables. It will also eat decaying matter that has washed ashore. A hermit crab may even eat its own skin once it molts, or sheds, it!

Hermit crabs are found in warm, tropical places such as the Caribbean, South America, Central America, and Australia. They are born in water but move to land once they mature. They prefer to live in small, cozy places such as within groups of rocks or under exposed tree roots.

Most hermit crab colonies contain around 100 of the little creatures. They tend to pile on top of each other to sleep and to travel in packs. This is why most experts recommend that if you keep a hermit crab as a pet, you should have more than one. (See the box on the next page for more information.) Though hermit crabs are less common as pets, they are a fascinating choice to consider. If you do keep some hermit crabs as pets, I think you will agree that they are wonderful!

Hermit Crabs as Pets

Hermit crabs make great pets. If you would like to purchase and raise hermit crabs as pets, follow these simple steps:

- Purchase an aquarium that is at least ten gallons.
- Set up a heater underneath the tank, and be sure to keep the temperature of the aquarium between seventy and eighty-five degrees Fahrenheit.
- Place sand or coconut fiber in the tank so the hermit crabs have a place to burrow.
- Arrange decorations in the tank, such as plastic plants.
- Put the hermit crabs in their new home.
- Give the hermit crabs access to both fresh food and water.
- Clean the aquarium regularly.

Example Item 1

Selected-Response: 1 point

DOK Level 2:

English Language Arts (ELA) Grade 6 Content Domain: Reading and Vocabulary

Standard: ELAGSE6L4. Determine or clarify the meaning of unknown and multiple-meaning words and phrases based on grade 6 reading and content, choosing flexibly from a range of strategies.

Which of these is the meaning of *mature* in the sentence?

They are born in water but move to land once they mature.

- A. grow useful
- B. develop fully
- C. grow curious
- D. become tired

Correct Answer: B

Explanation of Correct Answer: The correct answer is choice (B) develop fully. This sentence is explaining the growth cycle of hermit crabs, so “mature” references their full development. Choice (A) is incorrect because maturing does not mean growing useful. Choice (C) is incorrect because “mature” is referring to physical growth. Choice (D) is

incorrect because nothing indicates that hermit crabs become tired when they mature.

Example Item 2

Constructed-Response: 2 points

DOK Level 3:

English Language Arts (ELA) Grade 6 Content Domain: Reading and Vocabulary

Standard: ELAGSE6RI5. Analyze how a particular sentence, paragraph, chapter, or section fits into the overall structure of a text and contributes to the development of the ideas.

How does the last paragraph of the passage affect the passage as a whole?

Use details from the passage to support your answer.

Scoring Rubric

Points	Description
2	<p>The response achieves the following:</p> <ul style="list-style-type: none"> • Gives sufficient evidence of the ability to analyze how a paragraph fits into the overall structure of a text and to explain how it contributes to the development of ideas • Includes specific examples/details that make clear reference to the text • Adequately explains how a paragraph fits into the overall structure of a text and how it contributes to the development of ideas with clearly relevant information based on the text
1	<p>The response achieves the following:</p> <ul style="list-style-type: none"> • Gives limited evidence of the ability to analyze how a paragraph fits into the overall structure of a text or to explain how it contributes to the development of ideas • Includes vague/limited examples/details that make reference to the text • Explains how a paragraph fits into the overall structure of a text and how it contributes to the development of ideas with vague/limited information based on the text
0	<p>The response achieves the following:</p> <ul style="list-style-type: none"> • Gives no evidence of the ability to analyze how a paragraph fits into the overall structure of a text or to explain how it contributes to the development of ideas

Exemplar Response

Points Awarded	Sample Response
2	The last paragraph brings the passage full circle by supporting the information in the first paragraph. It explains how hermit crab colonies have 100 crabs, and if you keep them as pets, “you should have more than one.” This supports the claim in the first paragraph that hermit crabs “like to socialize and live in packs.”
1	The last paragraph supports the information in the first paragraph by explaining how hermit crabs would rather “socialize and live in packs” than be alone.
0	The last paragraph talks about the same things as what the first paragraph talks about.

Example Item 3

Extended Writing-Response: 7 points

DOK Level 4:

English Language Arts (ELA) Grade 6 Content Domain: Writing and Language

Standard: ELAGSE6W1. Use words, phrases, and clauses to clarify the relationships among claim(s) and reasons.

In this section, you will read two passages about an ongoing public debate as to whether television and movies reflect society or influence it. You will write an argumentative essay supporting either side of the debate in which you argue that television and movies reflect society or that they influence it.

Before you begin planning and writing, you will read the two passages. As you read the passages, think about what details from the passages you might use in your argumentative essay. These are the titles of the passages you will read:

1. **Movies and Television: A Reflection**
2. **Positive Influence, Please!**

Movies and Television: A Reflection

Movies and television reflect society because they tell stories about our social world. People enjoy stories about that world because they connect with stories about themselves. They also enjoy stories about other people, especially if they involve cheering for people who work their way out of tough situations.

Consider a television situation comedy about a middle-class family. The parents and their three children have many bad days that could be drawn from many real-life experiences. Their exaggerated ups and downs are humorous, but together the family survives. The show reflects society by showing a world to which most people can relate.

Sometimes the characters in the story are not people. Consider a cartoon movie about a lion family. The plot seems to be based on real animals. Male lions are competing to be the head of a family group. However, these lions also have names. They talk to each other. They sing. They show human emotions. In other words, the plot is really a human drama. It reflects society by portraying true family relationships.

Sometimes writers include elements of modern society in movies and television shows that are set in the past. They believe this helps more viewers imagine being part of the story. For example, consider a movie about a pirate who is both foreign and familiar. He can sail a tall ship, but he likes to stretch rules. He appears to be from the 1700s, but he behaves much more like a modern teen. Many parts of his character are clearly drawn from the experiences of real people. The movie reflects both historical and modern society.

These three examples are similar to television shows and movies that have been very popular with their audiences. They show that the best movie and television writers draw from the experiences of real people to tell their stories. When the characters seem real, the plots imitate life and the stories reflect our society.

Positive Influence, Please!

Movies and television have the power to change society. Why? Because people like to imitate each other. In fact, people are wired to imitate. Babies imitate the looks on their parents' faces. Young children learn how to talk by imitation.

Even teens and adults learn by imitation. They pick up social cues. They copy ways of speaking. They copy each other's clothes. They listen to each other's songs. They watch the latest movies and television shows. Partly they do this to explore the world in a safe way. Partly they do it to fit in with their peers. Mostly they do it by instinct, without thinking.

Millions of people watch movies and television shows. Because the characters on the screen are also people, they can prompt the audience to imitate them. They can change people's behavior. For example, in the 1970s, women all over the world copied the hairdo of an actress in a television series. Anyone whose hair could hold the famous flip wore the style. Similarly, in the 1990s, many young children learned the moves of a group of superheroes who appeared in both a television series and several full-length movies.

Just like children, teens and adults copy speech patterns from movies and television shows. This imitation of language appears to have a more lasting effect. For example, because it is shocking and adds drama, characters on some shows are disrespectful. People who mistake movie and television scripts for real life copy these characters. As a result, disrespectful language is creeping into everyday speech. The same characters behave badly toward each other. They have changed some people's ideas about how to behave in family groups.

However, all is not lost! There are situation comedies and movies that have changed society for the better. Several popular high school dramas show people from different social groups getting along and making friends. These same shows give teens good ideas about how to handle social problems and relationships.

Now that you have read “Movies and Television: A Reflection” and “Positive Influence, Please!,” create a plan for and write your argumentative essay.

WRITING TASK

There are many ways that television and movies reflect and influence society. Some people believe that television and movies reflect society, while other people believe that society influences television and movies.

Think about the ideas in the two passages, and then write an **argumentative essay** in your own words supporting either side of this debate.

Be sure to use information from BOTH passages as you write your **argumentative essay**. **Write your answer on the lines provided.**

Be sure to:

- Introduce your claim.
- Support your claim with logical reasons and relevant evidence from the passages.
- Organize the reasons and evidence logically.
- Develop your ideas clearly and use your own words, except when quoting directly from the passages.
- Identify the passages by title or number when using details or facts directly from the passages.
- Use words, phrases, or clauses to connect ideas and to clarify the relationships among claims, reasons, and evidence.
- Establish and maintain a formal style.
- Use clear language and vocabulary.
- Provide a conclusion that supports the argument presented. punctuation.
- Check your work for correct usage, grammar, spelling, capitalization, and punctuation.

The following is an example of a seven-point response. See the seven-point, two-trait rubric for a text-based argumentative response on pages 50 and 51 to see why this example would earn the maximum number of points.

People enjoy telling stories and hearing stories about people and places in our world. Since movies and television shows tell stories as a form of entertainment or education, it is difficult to determine if they influence us or just reflect how we are in our society. The author of the first passage, "Movies and Television: A Reflection," makes the strongest case that these stories mirror the way people are. These stories are told in different ways, using real people or animation, or using animals as characters. However, the feelings and reactions described reflect feelings we all have as human beings. We may be influenced by a dramatic plot, but that will not change who we are and how we live our lives.

The second passage, "Positive Influence, Please!," implies that people are heavily influenced by what they hear and see in movies and on television shows. It suggests that people change their language and behavior after viewing dramatic shows. The author is saying that people, by the way they learn, imitate all they hear and see. That assumption does not give individuals credit for having their own views and values. People may rethink their worldviews based on new information, but they make a conscious decision to change.

In all cultures, sharing stories with others is a way these societies maintain their heritage and sense of self. Therefore, it seems more reasonable to say that movies and television reflect society than to say that they influence it.

ENGLISH LANGUAGE ARTS (ELA) ADDITIONAL SAMPLE ITEMS

This section has two parts. The first part is a set of 11 sample items for the English Language Arts (ELA) portion of the EOG assessment. The second part contains a table that shows for each item the standard assessed, the DOK level, the correct answer (key), and a rationale/explanation about the key and distractors. The sample items can be utilized as a mini-test to familiarize students with the item formats found on the assessment.

All example and sample items contained in this guide are the property of the Georgia Department of Education.

Items 1 through 8

Read the poem “The Carpenter” and the story “The Carpenter’s Apprentice” and answer questions 1 through 8.

The Carpenter

A house is sketched on paper,
Then drawn on plans of blue.
But it is the carpenter’s careful labor
That makes the dream come true.

Calloused hands unroll the blueprint.
Keen eyes review with ease.
A young man might see a house,
But a home the carpenter sees.

He cuts and shapes with vision.
His goal is understood:
He converts the lines and numbers
Into lengths of measured wood.

Like an artist he wields his hammer,
Pounding rhythms to his own beat.
He sculpts and forms a framework
That painted walls will soon complete.

Like an athlete he climbs and balances.
Lifting, fastening bulky beams,
Building the backbone of a sturdy house,
He frames a family’s dreams.

Walls and windows, floors and doors,
The carpenter adds with care.
He knows a fireplace heats a house,
But a happy family warms the air.

When the home of dreams is ready,
An inner smile he then sets free.
A young man might see a house,
But a home the carpenter sees.

The Carpenter's Apprentice

Before Ben started to work with me, I had advised him to buy a quality set of tools. "Good tools are expensive," I had told him, "but they will last for years." On Ben's first day of work, the head of the cheap hammer he had bought flew off and put a hole in a wall.

One Monday as we ate our lunch in the truck outside the Pine Street house, Ben told me that he had made a few phone calls for us. "The lumber yard across town can deliver what we need tomorrow. We could finish the job by noon Friday!"

I turned and met his eyes. "I think I told you that I don't do business with that lumber yard anymore. The last order I got from them had warps, splits, and four-inch knots on every piece."

"But if we wait until the other delivery on Thursday, we won't finish the job until Monday or Tuesday of next week."

I continued to look at him. Ben was thinking of his plans for the weekend, but I was thinking of our obligation to the house's owner to do the job right using only quality materials.

"Ben," I sighed, "how would you like to live in this house?" He looked up at me quizzically, as though I were making him an offer. "Would you like to live in this house if it were built your way, using inferior lumber? Would you want to walk around on a floor with warped supports under it and sleep under a roof built with split and knotted wood? We need to do this right, Ben. You can't build a house twice."

A philosopher, I'm not sure who, once said something to the effect that when you finish building your house, you realize all that you have learned in the process—and you realize, too, that all you have learned you should have known before you started.

Item 1

Selected-Response: 1 point

Which detail from the story suggests that Ben needs to take his apprenticeship more seriously?

- A. Ben is thinking about his plans for the weekend.
- B. Ben puts a hole in a wall when using his hammer.
- C. Ben contacts a lumber yard about delivering supplies.
- D. Ben eats his lunch in a truck away from other workers.

Item 2

Selected-Response: 1 point

In the story, what does the carpenter believe is the MOST important lesson for Ben to learn?

- A. build a house only once
- B. use the best tools and materials
- C. do the work with care and consideration
- D. know everything before starting a project

Item 3

Selected-Response: 1 point

Which theme is shared by the story and the poem?

- A. Beginning carpenters require training.
- B. It is good to take pride in your work.
- C. It is good to ask many questions.
- D. Carpenters need special tools.

Item 4

Constructed-Response: 2 points

What is the MOST LIKELY reason the poet included the second stanza in the poem?

Use details from the poem to support your answer. Write your answer on the lines provided.

Calloused hands unroll the blueprint.
Keen eyes review with ease.
A young man might see a house,
But a home the carpenter sees.

Item 5**Selected-Response:** 1 point

Use the information in the box below to answer the question.

obligation *n.* burden, charge, debt, duty

Which word would **BEST** replace *obligation* in the story?

I continued to look at him. Ben was thinking of his plans for the weekend, but I was thinking of our obligation to the house's owner to do the job right using only quality materials.

- A. burden
- B. charge
- C. debt
- D. duty

Item 6**Selected-Response:** 1 pointWhich word would **BEST** replace *wields* in this stanza from the poem?

Like an artist he wields his hammer,
Pounding rhythms to his own beat.
He sculpts and forms a framework
That painted walls will soon complete.

- A. holds
- B. maintains
- C. shakes
- D. uses

Item 7

Selected-Response: 1 point

What does the poet compare a carpenter to in this stanza from the poem?

Like an artist he wields his hammer,
Pounding rhythms to his own beat.
He sculpts and forms a framework
That painted walls will soon complete.

- A. a creative person
- B. a sturdy house
- C. a reliable tool
- D. a young man

Item 8

Technology-Enhanced: 2 points

This question has two parts. Answer Part A, and then answer Part B.

Part A

How does the poet develop the character of the carpenter in the poem “The Carpenter”?

- A. The poet uses short, powerful, rhythmic lines.
- B. The poet outlines the sequence of steps to build a home.
- C. The poet uses phrases like “keen eyes” and “inner smile.”
- D. The poet describes working with “blueprints” and “beams.”

Part B

Which line from the poem BEST supports the answer in Part A?

- A. He cuts and shapes with vision.
- B. He converts the lines and numbers
- C. Pounding rhythms to his own beat.
- D. Walls and windows, floors and doors,

Item 9

Extended Constructed-Response: 4 points

From the narrator’s point of view, finish the story of “The Carpenter’s Apprentice.” Start with what Ben might say in response to the narrator. Use details from the poem “The Carpenter” in your answer.

Be sure to use descriptive words and phrases in your writing. Write your answer on the lines provided.

A large rectangular box containing ten horizontal lines for writing an answer.

Items 10 and 11

Extended Constructed-Response: 4 points

In this section, you will read about an ongoing public debate as to whether television and movies reflect society or influence it. You will write an argumentative essay supporting either side of the debate in which you argue that television and movies reflect society or that they influence it.

Before you begin planning and writing, you will read the two passages. As you read the passages, think about what details from the passages you might use in your argumentative essay. These are the titles of the passages you will read:

- 1. Movies and Television: A Reflection**
- 2. Positive Influence, Please!**

Movies and Television: A Reflection

Movies and television reflect society because they tell stories about our social world. People enjoy stories about that world because they connect with stories about themselves. They also enjoy stories about other people, especially if they involve cheering for people who work their way out of tough situations.

Consider a television situation comedy about a middle-class family. The parents and their three children have many bad days that could be drawn from many real-life experiences. Their exaggerated ups and downs are humorous, but together the family survives. The show reflects society by showing a world to which most people can relate.

Sometimes the characters in the story are not people. Consider a cartoon movie about a lion family. The plot seems to be based on real animals. Male lions are competing to be the head of a family group. However, these lions also have names. They talk to each other. They sing. They show human emotions. In other words, the plot is really a human drama. It reflects society by portraying true family relationships.

Sometimes writers include elements of modern society in movies and television shows that are set in the past. They believe this helps more viewers imagine being part of the story. For example, consider a movie about a pirate who is both foreign and familiar. He can sail a tall ship, but he likes to stretch rules. He appears to be from the 1700s, but he behaves much more like a modern teen. Many parts of his character are clearly drawn from the experiences of real people. The movie reflects both historical and modern society.

These three examples are similar to television shows and movies that have been very popular with their audiences. They show that the best movie and television writers draw from the experiences of real people to tell their stories. When the characters seem real, the plots imitate life and the stories reflect our society.

Positive Influence, Please!

Movies and television have the power to change society. Why? Because people like to imitate each other. In fact, people are wired to imitate. Babies imitate the looks on their parents' faces. Young children learn how to talk by imitation.

Even teens and adults learn by imitation. They pick up social cues. They copy ways of speaking. They copy each other's clothes. They listen to each other's songs. They watch the latest movies and television shows. Partly they do this to explore the world in a safe way. Partly they do it to fit in with their peers. Mostly they do it by instinct, without thinking.

Millions of people watch movies and television shows. Because the characters on the screen are also people, they can prompt the audience to imitate them. They can change people's behavior. For example, in the 1970s, women all over the world copied the hairdo of an actress in a television series. Anyone whose hair could hold the famous flip wore the style. Similarly, in the 1990s, many young children learned the moves of a group of superheroes who appeared in both a television series and several full-length movies.

Just like children, teens and adults copy speech patterns from movies and television shows. This imitation of language appears to have a more lasting effect. For example, because it is shocking and adds drama, characters on some shows are disrespectful. People who mistake movie and television scripts for real life copy these characters. As a result, disrespectful language is creeping into everyday speech. The same characters behave badly toward each other. They have changed some people's ideas about how to behave in family groups.

However, all is not lost! There are situation comedies and movies that have changed society for the better. Several popular high school dramas show people from different social groups getting along and making friends. These same shows give teens good ideas about how to handle social problems and relationships.

Item 11**Extended Writing-Response:** 7 points

Now that you have read “Movies and Television: A Reflection” and “Positive Influence, Please!,” create a plan for and write your argumentative essay.

WRITING TASK

There are many ways that television and movies reflect and influence society. Some people believe that television and movies reflect society, while other people believe that society influences television and movies.

Think about ideas in the two passages, and then write an **argumentative essay** in your own words supporting either side of this debate.

Be sure to use information for BOTH passages in your **argumentative essay**. **Write your answer on the lines provided.**

Be sure to:

- Introduce your claim.
- Support your claim with logical reasons and relevant evidence from the passages.
- Organize the reasons and evidence logically.
- Develop your ideas clearly and use your own words, except when quoting directly from the passages.
- Identify the passages by title or number when using details or facts directly from the passages.
- Use words, phrases, or clauses to connect ideas and to clarify the relationships among claims, reasons, and evidence.
- Establish and maintain a formal style.
- Use clear language and vocabulary.
- Provide a conclusion that supports the argument presented. punctuation.
- Check your work for correct usage, grammar, spelling, capitalization, and punctuation.

A large rectangular box containing 25 horizontal lines, intended for writing.

ENGLISH LANGUAGE ARTS (ELA) ADDITIONAL SAMPLE ITEM KEYS

Item	Standard/ Element	DOK Level	Correct Answer	Explanation
1	ELAGSE6RL1	3	A	The correct answer is choice (A) Ben is thinking about his plans for the weekend. Ben wants to rush his work so he can relax, but he is neglecting the responsibilities of his apprenticeship. Choice (B) is incorrect because making a mistake doesn't imply that Ben doesn't take his apprenticeship seriously. Choice (C) is incorrect because contacting another company can be a sign of taking work seriously. Choice (D) is incorrect because eating lunch away from construction work is likely safer and doesn't show lack of seriousness about work.
2	ELAGSE6RL1	3	C	The correct answer is choice (C) do the work with care and consideration. Throughout the story, the carpenter constantly tries to teach Ben to value quality, such as explaining why the materials from the lumber yard are unacceptable in his opinion. Choice (A) is incorrect because it is a misunderstanding of the phrase the carpenter uses to try to teach Ben about quality. Choice (B) is incorrect because using the right tools is only part of the carpenter's larger lesson about quality. Choice (D) is incorrect because nothing suggests that the carpenter expects his apprentice to know everything.
3	ELAGSE6RL2	3	B	The correct answer is choice (B) It is good to take pride in your work. The poem celebrates the work of a carpenter and the story clearly shows that the carpenter values quality. Choice (A) is incorrect because the poem does not mention an apprentice. Choice (C) is incorrect because neither the poem nor the story suggests anything about asking many questions. Choice (D) is incorrect because this is only a minor detail of the story and not a theme.
4	ELAGSE6RL5	3	N/A	See scoring rubric and exemplar responses on page 41.

Item	Standard/ Element	DOK Level	Correct Answer	Explanation
5	ELAGSE6L4c	2	D	The correct answer is choice (D) duty. Obligations, or duties, are responsibilities that one has to fulfill. Choice (A) is incorrect because obligations are not necessarily burdens. Choice (B) is incorrect because a charge does not refer to responsibilities or duties. Choice (C) is incorrect because nothing in the context of the story mentions money.
6	ELAGSE6L4a	2	D	The correct answer is choice (D) uses. Wielding something refers to holding it and using it to complete a task. Choice (A) is incorrect because wielding refers to more than just holding. Choice (B) is incorrect because nothing in the context suggests that the carpenter is maintaining something. Choice (C) is incorrect because nothing suggests that the carpenter is shaking the hammer.
7	ELAGSE6L5a	2	A	The correct answer is choice (A) a creative person. Artists and sculptors are creative people, and the poet is using them to describe the carpenter. Choice (B) is incorrect because nothing in the stanza suggests that the carpenter is a sturdy house. Choice (C) is incorrect because nothing suggests that the carpenter is a reliable tool. Choice (D) is incorrect because nothing suggests that the carpenter is a young man.

Item	Standard/ Element	DOK Level	Correct Answer	Explanation
8	ELACC6RL6	3	C/A	<p>The correct answer choices are (C) The poet uses phrases like “keen eyes” and “inner smile,” and (A) He cuts and shapes with vision.</p> <p>The poet creates a character within the poem “The Carpenter” or someone who is dedicated to his craft and is able to see things in his work that others may not. The answer choice for Part B shows the line from the poem that best supports the manner in which the poet develops the character of the carpenter. In Part A, choice (A) is incorrect because the use of short and powerful lines does not develop the character. Choice (B) is incorrect because the poem is not a step-by-step guide about how to build a home. Choice (D) is incorrect as there is no character development inherent in the mentioning of blueprints and beams as those are tools of the trade. The incorrect options in Part B support incorrect answers in Part A.</p>
9	ELAGSE6W3d	4	N/A	See exemplar responses on page 42 and the four-point holistic rubric beginning on page 46.
10	ELAGSE6RI8	3	N/A	See scoring rubric and exemplar responses on page 43.
11	ELAGSE6W1c	4	N/A	See exemplar response on page 44 and the seven-point, two-trait rubric beginning on page 50.

ENGLISH LANGUAGE ARTS (ELA) EXAMPLE SCORING RUBRICS AND EXEMPLAR RESPONSES

Item 4

Scoring Rubric

Points	Description
2	<p>The response achieves the following:</p> <ul style="list-style-type: none"> • Gives sufficient evidence of the ability to analyze how a stanza of a poem fits into the overall structure and to explain how it contributes to the text • Includes specific examples/details that make clear reference to the text • Adequately explains the purpose and contributions of the stanza of a poem with clearly relevant information based on the text
1	<p>The response achieves the following:</p> <ul style="list-style-type: none"> • Gives limited evidence of the ability to analyze how a stanza of a poem fits into the overall structure and to explain how it contributes to the text • Includes vague/limited examples/details that make reference to the text • Explains the purpose and contributions of the stanza of a poem with vague/limited information based on the text
0	<p>The response achieves the following:</p> <ul style="list-style-type: none"> • Gives no evidence of the ability to analyze how a stanza of a poem fits into the overall structure or to explain how it contributes to the text

Exemplar Response

Points Awarded	Sample Response
2	<p>The second stanza shows the carpenter’s experience and vision for the project. Because he reviews the blueprint “with ease,” it’s clear he understands it well. The line “But a home the carpenter sees” shows how he sees something more than just a structure in what he is building. By including this information, the poet shows there is more to the carpenter than someone who is just a builder; a carpenter is a creator.</p>
1	<p>The second stanza shows the carpenter’s experience and vision for the project. By including this information, the poet shows there is more to the carpenter than someone who is just a builder; a carpenter is a creator.</p>
0	<p>The second stanza shows the carpenter’s experience and vision for the project.</p>

Item 9

To view the four-point holistic rubric for a text-based narrative response, see pages 46 and 47.

Exemplar Response

Points Awarded	Sample Response
4	<p>Ben thought about what I had said and then admitted that building a house was more than just putting a bunch of wood together. He said, “You’re right. I would want to live in a home, one that is built with skill and vision. One that is a carpenter’s dream come true. There’s more to this job than just nails and wood.”</p> <p>I nodded in agreement. “There really is. We convert lines and numbers from the blueprint, but we do more than that.”</p> <p>Ben went on: “We are like artists, really. We are sculpting a house, not just building it. We add walls, windows, floors, and doors, and we do it with care. I want to make a house that makes people happy. I promise to do better from now on.”</p> <p>I knew that Ben meant it. There was a gleam in his eyes that showed he believed what he said. “Shall we get to it, then?” I asked.</p> <p>“Absolutely,” Ben replied. He picked up his hammer as if it were the paintbrush of an artist or the chisel of a sculptor.</p>
3	<p>Ben thought about what I had said. Then he admitted that building a house was more than just putting wood together. He said, “You’re right. I would want to live in a home, one that is built with skill and is a carpenter’s dream. There’s more to this job than just nails and wood.”</p> <p>I nodded. “There really is. We convert lines and numbers from the blueprint, but we do more than that.”</p> <p>Ben went on: “We are like artists sculpting a house. We don’t just build it. I want to make a house that makes people happy.”</p> <p>I knew that Ben meant it. “Shall we get to it, then?” I asked.</p> <p>“Absolutely,” Ben replied.</p>
2	<p>Ben thought about what I had said. Then he said that building a house was more than putting wood together. He said he would want to live in a home that’s a dream.</p> <p>I said, “We take lines and numbers and make it into a home.”</p> <p>Ben said, “I want to make a house that makes people happy.”</p>
1	<p>Ben said that building a house was more than putting wood together. He said he would want to live in a home that’s a dream.</p> <p>I said we make houses into homes.</p> <p>Ben said he wants to make a house that makes people happy.</p>
0	<p>Ben said he wanted to be an artist with wood.</p>

Item 10

Scoring Rubric

Points	Description
2	<p>The response achieves the following:</p> <ul style="list-style-type: none"> • Gives sufficient evidence of the ability to evaluate the arguments and claims in two texts and to assess the relevance and soundness of the argument/evidence • Includes specific examples/details that make clear reference to the texts • Adequately explains the arguments and claims in two texts and the assessment of evidence with clearly relevant information based on the texts
1	<p>The response achieves the following:</p> <ul style="list-style-type: none"> • Gives limited evidence of the ability to evaluate the arguments and claims in two texts and to assess the relevance and soundness of the argument/evidence • Includes vague/limited examples/details that make reference to the texts • Explains the arguments and claims in two texts and the assessment of evidence with clearly relevant information based on the texts
0	<p>The response achieves the following:</p> <ul style="list-style-type: none"> • Gives no evidence of the ability to evaluate the arguments and claims in two texts or to assess the relevance and soundness of the argument/evidence

Exemplar Response

Points Awarded	Sample Response
2	<p>In “Movies and Television: A Reflection,” the author gives three concrete examples to support his claim that movies and TV reflect society. He explains how situation comedies draw from real-life experiences that most people watching can relate to. The author even explains that animated cartoons about animals reflect society because the animals display human emotions and interact like humans. Similar to that, the author also explains that modern movies set in the past will even have characters that are more similar to people in modern times. The author says that any story with realistic characters will reflect society.</p>
1	<p>I think the author of the first passage did a better job because her point of view was much clearer and easier to understand. That author stayed focused on the idea that movies and TV shows reflect society. She gave many examples why. The author of the second passage seemed to not be sure whether imitating things in movies or on TV is a good idea or not because he explains that some imitation can lead to disrespectful behavior and some can lead to good behavior.</p>
0	<p>I think that movies and TV shows do reflect society.</p>

Item 11

The following is an example of a seven-point response. See the seven-point, two-trait rubric for a text-based argumentative response on pages 50 and 51 to see why this example would earn the maximum number of points.

People enjoy telling stories and hearing stories about people and places in our world. Since movies and television shows tell stories as a form of entertainment or education, it is difficult to determine if they influence us or just reflect how we are in our society. The author of the first passage, "Movies and Television: A Reflection," makes the strongest case that these stories mirror the way people are. These stories are told in different ways, using real people or animation, or using animals as characters. However, the feelings and reactions described reflect feelings we all have as human beings. We may be influenced by a dramatic plot, but that will not change who we are and how we live our lives.

The second passage, "Positive Influence, Please!," implies that people are heavily influenced by what they hear and see in movies and on television shows. It suggests that people change their language and behavior after viewing dramatic shows. The author is saying that people, by the way they learn, imitate all they hear and see. That assumption does not give individuals credit for having their own views and values. People may rethink their worldviews based on new information, but they make a conscious decision to change.

In all cultures, sharing stories with others is a way these societies maintain their heritage and sense of self. Therefore, it seems more reasonable to say that movies and television reflect society than to say that they influence it.

ENGLISH LANGUAGE ARTS (ELA) WRITING RUBRICS

Grade 6 items that are not machine-scored—i.e., constructed-response, extended constructed-response, and extended writing-response items—are manually scored using either a holistic rubric or a two-trait rubric.

Four-Point Holistic Rubric

Genre: Narrative

A holistic rubric essentially has one main criterion. On the Georgia Milestones EOG assessment, a holistic rubric contains a single point scale ranging from zero to four. Each point value represents a qualitative description of the student's work. To score an item on a holistic rubric, the scorer or reader need only choose the description and associated point value that best represents the student's work. Increasing point values represent a greater understanding of the content and, thus, a higher score.

Seven-Point, Two-Trait Rubric

Genre: Argumentative or Informational/Explanatory

A two-trait rubric, on the other hand, is an analytic rubric with two criteria, or traits. On the Georgia Milestones EOG assessment, a two-trait rubric contains two point scales for each trait ranging from zero to three on one scale and zero to four on the other.

A score is given for each of the two criteria/traits, for a total of seven possible points for the item. To score an item on a two-trait rubric, a scorer or reader must choose the description and associated point value for each criteria/trait that best represents the student's work. The two scores are added together. Increasing point values represent a greater understanding of the content and, thus, a higher score.

On the following pages are the rubrics that will be used to evaluate writing on the Georgia Milestones Grade 6 English Language Arts (ELA) EOG assessment.

Four-Point Holistic Rubric

Genre: Narrative

Writing Trait	Points	Criteria
<p><i>This trait examines the writer's ability to effectively develop real or imagined experiences or events using effective techniques, descriptive details, and clear event sequences based on a text that has been read.</i></p>	4	<p><i>The student's response is a well-developed narrative that fully develops a real or imagined experience based on text as a stimulus.</i></p> <ul style="list-style-type: none"> • Effectively establishes a situation and introduces a narrator and/or characters • Organizes an event sequence that unfolds naturally • Effectively uses narrative techniques, such as dialogue, description, and pacing, to develop rich, interesting experiences, events, and/or characters • Uses a variety of words and phrases consistently to convey the sequence of events and signal shifts from one time frame or setting to another • Uses precise words, phrases, and sensory language consistently to convey experiences and events • Provides a conclusion that follows from the narrated experiences or events • Integrates ideas and details from source material effectively • Has very few or no errors in usage and/or conventions that interfere with meaning*
	3	<p><i>The student's response is a complete narrative that develops a real or imagined experience based on text as a stimulus.</i></p> <ul style="list-style-type: none"> • Establishes a situation and introduces one or more characters • Organizes events in a clear, logical order • Uses narrative techniques, such as dialogue, description, and pacing, to develop experiences, events, and/or characters • Uses words and/or phrases to indicate sequence of events and signal shifts from one time frame or setting to another • Uses words, phrases, and details to convey experiences and events • Provides an appropriate conclusion • Integrates some ideas and/or details from source material • Has a few minor errors in usage and/or conventions that interfere with meaning*
	2	<p><i>The student's response is an incomplete or oversimplified narrative based on text as a stimulus.</i></p> <ul style="list-style-type: none"> • Introduces a vague situation and at least one character • Organizes events in a sequence but with some gaps or ambiguity • Attempts to use a narrative technique, such as dialogue, description, and pacing, to develop experiences, events, and/or characters • Uses occasional signal words inconsistently to indicate sequence of events and signal shifts from one time frame or setting to another • Uses some words or phrases inconsistently to convey experiences and events • Provides a weak or ambiguous conclusion • Attempts to integrate ideas or details from source material • Has frequent errors in usage and conventions that sometimes interfere with meaning*

Four-Point Holistic Rubric

Genre: Narrative (continued)

Writing Trait	Points	Criteria
<i>This trait examines the writer's ability to effectively develop real or imagined experiences or events using effective techniques, descriptive details, and clear event sequences based on a text that has been read.</i>	1	<p><i>The student's response provides evidence of an attempt to write a narrative based on text as a stimulus.</i></p> <ul style="list-style-type: none"> • Response is a summary of the story • Provides a weak or minimal introduction of a situation or a character • May be too brief to demonstrate a complete sequence of events • Shows little or no attempt to use dialogue, description, and pacing to develop experiences, events, and/or characters • Uses words that are inappropriate, overly simple, or unclear • Provides few, if any, words that convey experiences, or events, or signal shifts from one time frame or setting to another • Provides a minimal or no conclusion • May use few, if any, ideas or details from source material • Has frequent major errors in usage and conventions that interfere with meaning*
	0	<p><i>The student's response is flawed for various reasons and will receive a condition code:</i></p> <p>The condition codes can be found on page 81 of this guide.</p>

*Students are responsible for language conventions learned in their current grade as well as in prior grades. Refer to the language skills for each grade to determine the grade-level expectations for grammar, syntax, capitalization, punctuation, and spelling. Also refer to the "Language Progressive Skills, by Grade" chart in Appendix A for those standards that need continued attention beyond the grade in which they were introduced.

Seven-Point, Two-Trait Rubric

Trait 1 for Informational/Explanatory Genre

Writing Trait	Points	Criteria
<p>Idea Development, Organization, and Coherence</p> <p><i>This trait examines the writer's ability to effectively establish a controlling idea and to support the idea with evidence from the text(s) read and to elaborate on the idea with examples, illustrations, facts, and other details in order. The writer must integrate the information from the text(s) into his/her own words and arrange the ideas and supporting evidence (from text that they have read) in order to create cohesion for an informative/explanatory essay.</i></p>	4	<p><i>The student's response is a well-developed informative/explanatory text that examines a topic in depth and conveys ideas and information clearly based on text as a stimulus.</i></p> <ul style="list-style-type: none"> • Effectively introduces a topic • Effectively organizes ideas, concepts, and information using various strategies such as definition, classification, comparison/contrast, and cause/effect • Effectively develops a topic with multiple, relevant facts, definitions, concrete details, quotations, or other information and examples related to the topic • Effectively uses transitions to connect and clarify relationships among ideas • Uses precise language and domain-specific vocabulary to effectively inform and explain about the topic • Establishes and maintains a formal style • Provides a strong concluding statement or section that follows from the information or explanation presented
	3	<p><i>The student's response is a complete informative/explanatory text that examines a topic and presents information clearly based on text as a stimulus.</i></p> <ul style="list-style-type: none"> • Introduces a topic • Generally organizes ideas, concepts, and information • Develops a topic with a few facts, definitions, concrete details, quotations, or other information and examples • Uses some transitions to connect and clarify relationships among ideas, but relationships may not always be clear • Uses some precise language and domain-specific vocabulary to inform and explain about the topic • Maintains a formal style, for the most part • Provides a concluding statement or section
	2	<p><i>The student's response is an incomplete or oversimplified informative/explanatory text that cursorily examines a topic.</i></p> <ul style="list-style-type: none"> • Attempts to introduce a topic • Attempts to develop a topic with too few details • Ineffectively organizes ideas, concepts, and information • Uses limited language and vocabulary that does not inform or explain the topic • Uses few transitions to connect and clarify relationships among ideas • Uses a formal style inconsistently or uses an informal style • Provides a weak concluding statement or section
	1	<p><i>The student's response is a weak attempt to write an informative/explanatory text that examines a topic.</i></p> <ul style="list-style-type: none"> • May not introduce a topic or topic is unclear • May not develop a topic • May be too brief to group any related ideas together • May not use any linking words to connect ideas • Uses vague, ambiguous, or repetitive language • Uses a very informal style • Provides a minimal or no concluding statement or section
	0	<p><i>The student's response is flawed for various reasons and will receive a condition code: The condition codes can be found on page 81 of this guide.</i></p>

Seven-Point, Two-Trait Rubric

Trait 2 for Informational/Explanatory Genre

Writing Trait	Points	Criteria
Language Usage and Conventions <i>This trait examines the writer's ability to demonstrate control of sentence formation, usage, and mechanics as embodied in the grade-level expectations of the language standards.</i>	3	<i>The student's response demonstrates full command of language usage and conventions.</i> <ul style="list-style-type: none"> • Effectively varies sentence patterns for meaning, reader/listener interest, and style • Shows command of language and conventions when writing • Any errors in usage and conventions do not interfere with meaning*
	2	<i>The student's response demonstrates partial command of language usage and conventions.</i> <ul style="list-style-type: none"> • Varies some sentence patterns for meaning, reader/listener interest, and style • Shows some knowledge of languages and conventions when writing • Has minor errors in usage and conventions with no significant effect on meaning*
	1	<i>The student's response demonstrates weak command of language usage and conventions.</i> <ul style="list-style-type: none"> • Has fragments, run-ons, and/or other sentence structure errors • Shows little knowledge of languages and conventions when writing • Has frequent errors in usage and conventions that interfere with meaning*
	0	<i>The student's response is flawed for various reasons and will receive a condition code:</i> The condition codes can be found on page 81 of this guide.

*Students are responsible for language conventions learned in their current grade as well as in prior grades. Refer to the language skills for each grade to determine the grade-level expectations for grammar, syntax, capitalization, punctuation, and spelling. Also refer to the "Language Progressive Skills, by Grade" chart in Appendix A for those standards that need continued attention beyond the grade in which they were introduced.

Seven-Point, Two-Trait Rubric

Trait 1 for Argumentative Genre

Writing Trait	Points	Criteria
<p>Idea Development, Organization, and Coherence</p> <p><i>This trait examines the writer's ability to effectively establish a claim, to support the claim with evidence from the text(s) read, and to elaborate on the claim with examples, illustrations, facts, and other details. The writer must integrate the information from the text(s) into his/her own words and arrange the ideas and supporting evidence in order to create cohesion for an argument essay.</i></p>	4	<p><i>The student's response is a well-developed argument that effectively relates and supports claims with clear reasons and relevant text-based evidence.</i></p> <ul style="list-style-type: none"> • Effectively introduces claim(s) • Organizes supporting reasons and evidence clearly • Supports claim(s) with clear reasons and relevant evidence using specific, well-chosen facts, details, or other information from credible sources and demonstrating a good understanding of the topic or texts • Uses words, phrases, or clauses effectively to connect ideas and clarify relationships among claim(s) and reasons • Establishes and maintains formal style that is appropriate for the task, purpose, and audience • Provides a strong concluding statement or section that logically follows from the argument presented
	3	<p><i>The student's response is a complete argument that relates and supports claims with some text-based evidence.</i></p> <ul style="list-style-type: none"> • Introduces claim(s) • Organizes supporting reasons and evidence • Supports claim(s) with reasons and evidence using some facts, details, or other information from generally credible sources • Uses words, phrases, or clauses to connect ideas and link claim(s) and reasons • Uses formal style fairly consistently for the task, purpose, and audience • Provides a concluding statement or section that follows from the argument presented
	2	<p><i>The student's response is an incomplete or oversimplified argument that partially supports claims with loosely related text-based evidence.</i></p> <ul style="list-style-type: none"> • Attempts to introduce claim(s) • Attempts to organize supporting reasons and evidence • Attempts to support claim(s) with facts, reasons and other evidence sometimes, but logic and relevancy are often unclear • Uses few words, phrases, or clauses to connect ideas and link claim(s) and reasons; connections are not always clear • Uses formal style inconsistently or uses informal style that does not fit task, purpose, or audience • Provides a weak concluding statement or section that may not follow the argument presented
	1	<p><i>The student's response is a weak attempt to write an argument and does not support claims with adequate text-based evidence.</i></p> <ul style="list-style-type: none"> • May not introduce claim(s) • May be too brief to demonstrate an organizational structure, or no structure is evident • May not support claim(s) • Uses minimal or no words, phrases, or clauses to connect ideas • Uses very informal style that is not appropriate for task, purpose, or audience • Provides a minimal or no concluding statement or section
	0	<p><i>The student's response is flawed for various reasons and will receive a condition code: The condition codes can be found on page 81 of this guide.</i></p>

Seven-Point, Two-Trait Rubric

Trait 2 for Argumentative Genre

Writing Trait	Points	Criteria
Language Usage and Conventions <i>This trait examines the writer's ability to demonstrate control of sentence formation, usage, and mechanics as embodied in the grade-level expectations of the language standards.</i>	3	<i>The student's response demonstrates full command of language usage and conventions.</i> <ul style="list-style-type: none"> • Effectively varies sentence patterns for meaning, reader/listener interest, and style • Shows command of language and conventions when writing • Any errors in usage and conventions do not interfere with meaning*
	2	<i>The student's response demonstrates partial command of language usage and conventions.</i> <ul style="list-style-type: none"> • Varies some sentence patterns for meaning, reader/listener interest, and style • Shows some knowledge of languages and conventions when writing • Has minor errors in usage and conventions with no significant effect on meaning*
	1	<i>The student's response demonstrates weak command of language usage and conventions.</i> <ul style="list-style-type: none"> • Has fragments, run-ons, and/or other sentence structure errors • Shows little knowledge of languages and conventions when writing • Has frequent errors in usage and conventions that interfere with meaning*
	0	<i>The student's response is flawed for various reasons and will receive a condition code:</i> The condition codes can be found on page 81 of this guide.

*Students are responsible for language conventions learned in their current grade as well as in prior grades. Refer to the language skills for each grade to determine the grade-level expectations for grammar, syntax, capitalization, punctuation, and spelling. Also refer to the "Language Progressive Skills, by Grade" chart in Appendix A for those standards that need continued attention beyond the grade in which they were introduced.

MATHEMATICS

DESCRIPTION OF TEST FORMAT AND ORGANIZATION

The Georgia Milestones Mathematics EOG assessment is primarily a criterion-referenced test, designed to provide information about how well a student has mastered the grade-level state-adopted content standards in Mathematics. Each student will receive one of four Achievement Level designations, depending on how well the student has mastered the content standards. The four Achievement Level designations are Beginning Learner, Developing Learner, Proficient Learner, and Distinguished Learner. In addition to criterion-referenced information, the Georgia Milestones measures will also include a limited sample of nationally norm-referenced items to provide a signal of how Georgia students are achieving relative to their peers nationally. The norm-referenced information provided is supplementary to the criterion-referenced Achievement Level designation and will not be utilized in any manner other than to serve as a barometer of national comparison. Only the criterion-referenced scores and Achievement Level designations will be utilized in the accountability metrics associated with the assessment program (such as student growth measures, educator-effectiveness measures, or the CCRPI).

The Grade 6 Mathematics EOG assessment consists of both operational items (contribute to a student's criterion-referenced and/or norm-referenced score) and field test items (newly written items that are being tried out and do not contribute to the student's score). A subset of the norm-referenced operational items have been verified as aligned to the course content standards by Georgia educators and will also contribute to the criterion-referenced score and Achievement Level designation. The other norm-referenced items will contribute only to the national percentile rank, which is provided as supplemental information.

With the inclusion of the norm-referenced items, students may encounter items for which they have not received direct instruction. These items will not contribute to the students' criterion-referenced Achievement Level designation; only items that align to the course content standards will contribute to the criterion-referenced score. Students should be instructed to try their best should they ask about an item that is not aligned to the content they have learned as part of the course.

The table on the following page outlines the number and types of items included on the Grade 6 Mathematics EOG assessment.

Grade 6 Mathematics EOG Assessment Design

Description	Number of Items	Points for CR ¹ Score	Points for NRT ² Feedback
CR Selected-Response Items	39	39	0
NRT Selected-Response Items	20 ³	9 ⁴	20
CR Technology-Enhanced Items	1	2	0
CR Constructed-Response Items	2	4	0
CR Extended Constructed-Response Items	1	4	0
CR Field Test Items	10	0	0
Total Items/Points⁵	73	58	20

¹CR—Criterion-Referenced: items aligned to state-adopted content standards

²NRT—Norm-Referenced Test: items that will yield a national comparison; may or may not be aligned to state-adopted content standards

³Of these items, approximately 9 will contribute to both the CR scores and NRT feedback. The other 11 of these items will contribute to NRT feedback only and will not impact the student's Achievement Level designation, scale score, or grade conversion.

⁴Alignment of national NRT items to course content standards was verified by a committee of Georgia educators. Only approved, aligned NRT items will contribute to a student's CR Achievement Level designation, scale score, and grade conversion score.

⁵Of the 73 total items, 52 items contribute to the CR score, for a total of 58 points; 20 total items contribute to NRT feedback, for a total of 20 points.

The test will be given in two sections. Section 1 is divided into two parts. Students may have up to 85 minutes per section to complete Sections 1 and 2. The total estimated testing time for the Grade 6 Mathematics EOG assessment ranges from approximately 120 to 170 minutes. Total testing time describes the amount of time students have to complete the assessment. It does not take into account the time required for the test examiner to complete pre-administration and post-administration activities (such as reading the standardized directions to students). Sections 1 and 2 must be scheduled such that both will be completed in a single day or over the course of two consecutive days (one section each day) and should be completed within the same week following the district's testing protocols for the EOG measures (in keeping with state guidance).

During the Mathematics EOG assessment, a formula sheet will be available for students to use. There is an example of the formula sheet in the Mathematics Additional Sample Items section of this guide. Another feature of the Grade 6 Mathematics EOG assessment is that students may use a basic function calculator in Part B of Section 1 and in all of Section 2.

CONTENT MEASURED

The Grade 6 Mathematics assessment will measure the Grade 6 standards that are described at www.georgiastandards.org.

The content of the assessment is organized into five groupings, or domains, of standards for the purposes of providing feedback on student performance. A content

domain is a reporting category that *broadly* describes and defines the content of the course, as measured by the EOG assessment. The standards for Grade 6 Mathematics are grouped into five domains: Ratios and Proportional Relationships, The Number System, Expressions and Equations, Geometry, and Statistics and Probability. Each domain was created by organizing standards that share similar content characteristics. The content standards describe the level of expertise that Grade 6 Mathematics educators should strive to develop in their students. Educators should refer to the content standards for a full understanding of the knowledge, concepts, and skills subject to be assessed on the EOG assessment.

The approximate proportional number of points associated with each domain is shown in the following table. A range of cognitive levels will be represented on the Grade 6 Mathematics EOG assessment. Educators should always use the content standards when planning instruction.

GRADE 6 MATHEMATICS: DOMAIN STRUCTURES AND CONTENT WEIGHTS

Domain	Standard	Approximate Weight
Ratios and Proportional Relationships	MGSE6.RP.1 MGSE6.RP.2 MGSE6.RP.3	12%
The Number System	MGSE6.NS.1 MGSE6.NS.5 MGSE6.NS.2 MGSE6.NS.6 MGSE6.NS.3 MGSE6.NS.7 MGSE6.NS.4 MGSE6.NS.8	30%
Expressions and Equations	MGSE6.EE.1 MGSE6.EE.6 MGSE6.EE.2 MGSE6.EE.7 MGSE6.EE.3 MGSE6.EE.8 MGSE6.EE.4 MGSE6.EE.9 MGSE6.EE.5	23%
Geometry	MGSE6.G.1 MGSE6.G.2 MGSE6.G.3 MGSE6.G.4	18%
Statistics and Probability	MGSE6.SP.1 MGSE6.SP.4 MGSE6.SP.2 MGSE6.SP.5 MGSE6.SP.3	17%

ITEM TYPES

The Mathematics portion of the Grade 6 EOG assessment consists of selected-response, technology-enhanced, constructed-response, and extended constructed-response items.

A selected-response item, sometimes called a multiple-choice item, is defined as a question, problem, or statement that appears on a test followed by several answer choices, sometimes called options or response choices. The incorrect choices, called distractors, usually reflect common errors. The student's task is to choose, from the alternatives provided, the best answer to the question posed in the stem (the question). The Mathematics selected-response items will have four answer choices.

A technology-enhanced item is an innovative way to measure student skills and knowledge using scaffolding within a multi-step process. For Mathematics, there are two specific types of technology-enhanced items being used—a multiple-select item and a multiple-part item. In multiple-select items, the student is asked to pick two or three correct responses from five or six possible answer options. In multiple-part items, the student responds to a two-part item that combines multiple-choice and/or multiple-select. For these item types, the student selects the responses from the choices provided or writes a response. A student receives two points for selecting all correct answers or partial credit is awarded for special combinations.

A constructed-response item asks a question and solicits the student to provide a response he or she constructs on his or her own, as opposed to selecting from options provided. The constructed-response items on the EOG assessment will be worth two points. Partial credit may be awarded if part of the response is correct.

An extended constructed-response item is a specific type of constructed-response item that elicits a longer, more detailed response from the student than a two-point constructed-response item. The extended constructed-response items on the EOG assessment will be worth four points. Partial credit may be awarded if part of the response is correct.

MATHEMATICS DEPTH OF KNOWLEDGE EXAMPLE ITEMS

Example items that represent the applicable DOK levels across various Grade 6 Mathematics content domains are provided.

All example and sample items contained in this guide are the property of the Georgia Department of Education.

Example Item 1

Selected-Response: 1 point

DOK Level 1:

Mathematics Grade 6 Content Domain: The Number System

Standard: MGSE6.NS.6. Understand a rational number as a point on the number line. Extend number line diagrams and coordinate axes familiar from previous grades to represent points on the line and in the plane with negative number coordinates. c. Find and position integers and other rational numbers on a horizontal or vertical number line diagram; find and position pairs of integers and other rational numbers on a coordinate plane.

Look at point P on the coordinate grid.

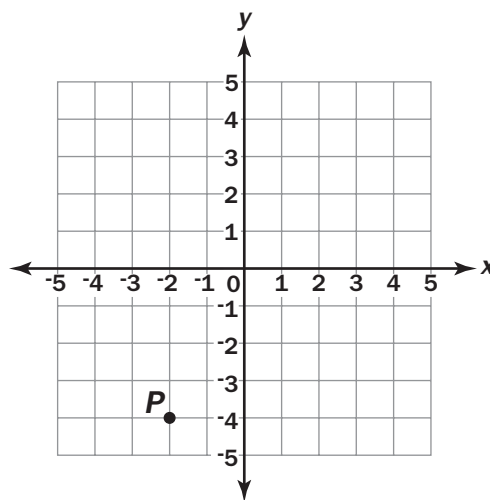

What are the coordinates of point P ?

- A. $(2, 4)$
- B. $(4, 2)$
- C. $(-2, -4)$
- D. $(-4, -2)$

Correct Answer: C

Explanation of Correct Answer: The correct answer is choice (C) $(-2, -4)$. Point P is located 2 units to the left of the origin, which gives us a value of -2 for x , and 4 units down, which gives us a value of -4 for y . Choice (A) is incorrect because the signs of the numbers are ignored. Choice (B) is incorrect because the coordinates are interchanged.

and the signs are ignored. Choice (D) is incorrect because it interchanges the coordinates.

Example Item 2

Selected-Response: 1 point

DOK Level 2:

Mathematics Grade 6 Content Domain: Ratios and Proportional Relationships

Standard: MGSE6.RP.3. Use ratio and rate reasoning to solve real-world and mathematical problems utilizing strategies such as tables of equivalent ratios, tape diagrams (bar models), double number line diagrams, and/or equations. b. Solve unit rate problems including those involving unit pricing and constant speed. *For example, if it took 7 hours to mow 4 lawns, then at that rate, how many lawns could be mowed in 35 hours? At what rate were lawns being mowed?*

John orders 25 prints from a photo store for \$13.00.

What is the cost per print?

- A. \$0.12
- B. \$0.38
- C. \$0.52
- D. \$1.92

Correct Answer: C

Explanation of Correct Answer: The correct answer is choice (C) \$0.52. The cost per print is equal to the total cost divided by the number of prints: $\frac{\$13.00}{25} = \0.52 .

Choice (A) is incorrect because it is the result of subtracting 0.13 from 0.25. Choice (B)

is incorrect because it is the result of adding 0.13 and 0.25. Choice (D) is incorrect because it is the result of dividing 25 by 13.

Example Item 3**Selected-Response:** 1 point**DOK Level 3:****Mathematics Grade 6 Content Domain:** Geometry

Standard: MGSE6.G.3. Draw polygons in the coordinate plane given coordinates for the vertices; use coordinates to find the length of a side joining points with the same first coordinate or the same second coordinate. Apply these techniques in the context of solving real-world and mathematical problems.

Harry is drawing trapezoid $PQRS$. He plots vertices P and Q on the coordinate grid as shown.

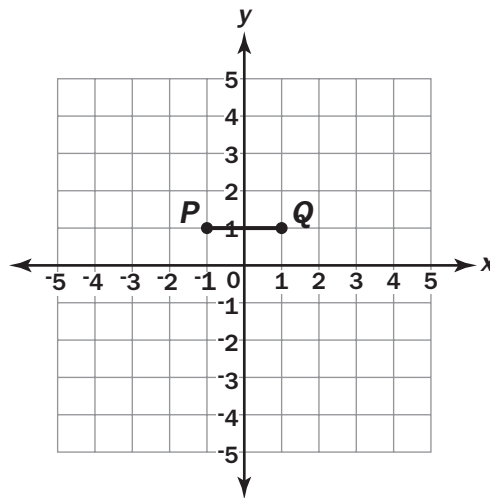

Harry wants the trapezoid to have a height of 3 units.

Which of these could be the coordinates of vertices R and S of trapezoid $PQRS$?

- A. $R(2, 3)$ and $S(-3, 3)$
- B. $R(3, -3)$ and $S(-4, -3)$
- C. $R(4, -2)$ and $S(-2, -2)$
- D. $R(-2, 4)$ and $S(2, 2)$

Correct Answer: C

Explanation of Correct Answer: The correct answer is choice (C) $R(4, -2)$ and $S(-2, -2)$. The given coordinates form a trapezoid. From -2 to 1 on the y -axis is a height of 3 units. While choices (A) and (B) do give coordinates that form trapezoids, the heights are not 3 units. In choice (A), the height is 2 units. In choice (B), the height is 4 units. Choice (D) is incorrect because the given coordinates do not form a trapezoid.

MATHEMATICS ADDITIONAL SAMPLE ITEMS

This section has two parts. The first part is a set of 13 sample items for the Mathematics portion of the EOG assessment. The second part contains a table that shows for each item the standard assessed, the DOK level, the correct answer (key), and a rationale/explanation about the key and distractors. The sample items can be utilized as a mini-test to familiarize students with the item formats found on the assessment.

All example and sample items contained in this guide are the property of the Georgia Department of Education.

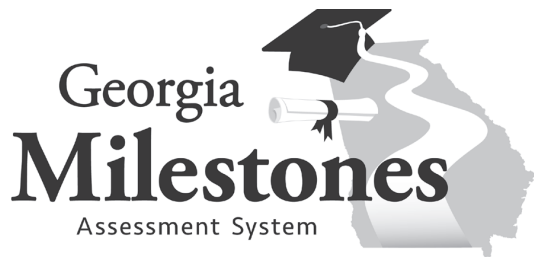

Mathematics Formula Sheet

You can find mathematics formula sheets on the Georgia Milestones webpage at <http://www.gadoe.org/Curriculum-Instruction-and-Assessment/Assessment/Pages/Georgia-Milestones-Assessment-System.aspx>.

Look under “EOG Resources.”

Item 1**Selected-Response:** 1 point**Look at the expression.**

$$25 + 45$$

Which of these is an equivalent expression?

- A. $5(5 + 45)$
- B. $5(5 + 9)$
- C. $5(20 + 40)$
- D. $5(25 + 9)$

Item 2**Selected-Response:** 1 point**Which inequality is true and why?**

- A. $-1 > -4$ because -1 is to the right of -4 on a horizontal number line oriented left to right
- B. $-4 > -5$ because -4 is to the left of -5 on a horizontal number line oriented left to right
- C. $-8 > -7$ because -8 is to the right of -7 on a horizontal number line oriented left to right
- D. $-9 > -6$ because -9 is to the left of -6 on a horizontal number line oriented left to right

Item 3

Selected-Response: 1 point

Look at the figure.

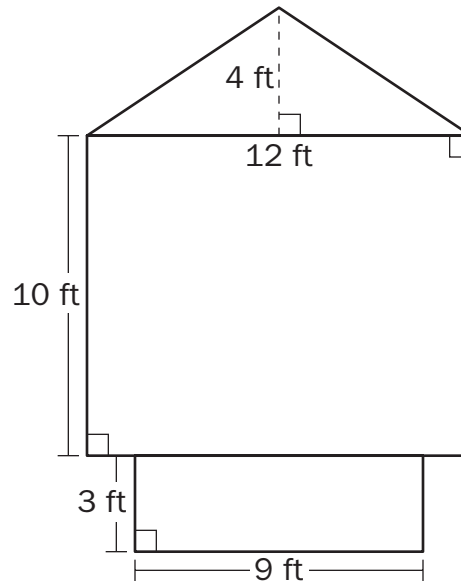

What is the total area of this figure?

- A. 141 ft²
- B. 171 ft²
- C. 180 ft²
- D. 195 ft²

Item 4**Selected-Response:** 1 point

Faye made a case for her electronic reading device using the net shown.

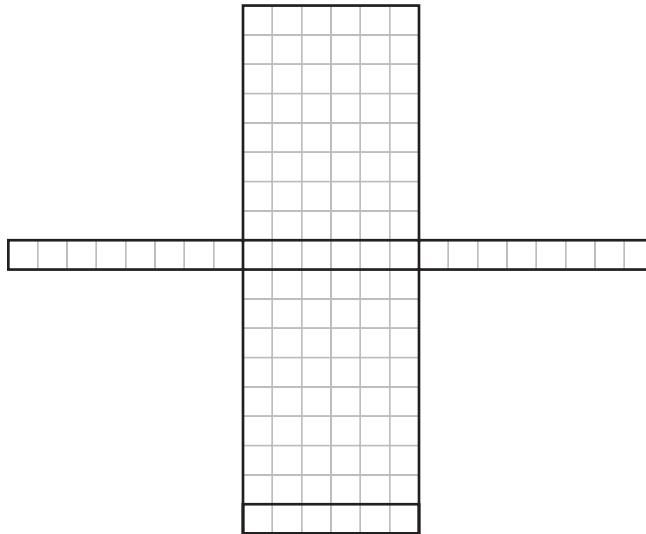
Faye's Case

KEY
<input type="checkbox"/> = 1 square inch

What is the total surface area, in square inches, of Faye's case?

- A. 62
- B. 96
- C. 108
- D. 124

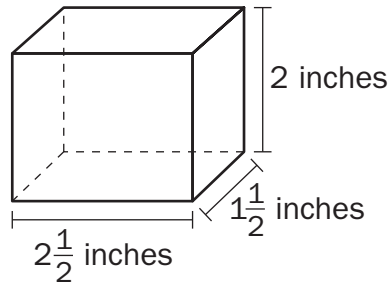
Item 5**Selected-Response:** 1 point**Look at the box in the shape of a right rectangular prism.**

Lorraine plans to fill this box with cubes of the same size. Each cube has side lengths of $\frac{1}{2}$ inch.

How many cubes can fit inside this box without empty space?

- A. 4
- B. 5
- C. 32
- D. 60

Item 6

Selected-Response: 1 point

The line plot shows the ages of the children who had their photographs taken at a photography studio during a certain week.

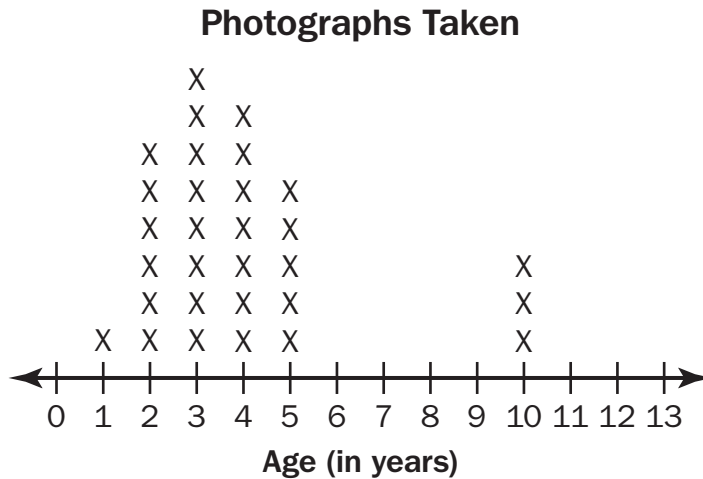

Which statement about the children who had their photographs taken does the spread of the data describe?

- A. The average age of the children was 3 years.
- B. The most common age of the children was 10 years.
- C. The ages of half of the children were 6 years or less.
- D. The ages of the children ranged from 1 year to 10 years.

Item 7

Selected-Response: 1 point

Look at the inequality.

$$3y > 27$$

Which set of values for y will make this inequality true?

- A. 4, 5, 8
- B. 5, 7, 9
- C. 9, 12, 14
- D. 11, 13, 22

Item 8

Selected-Response: 1 point

Harriet has \$25 in her savings account. She will add \$5 each week and not take any money out of her account.

Which expression represents the amount of money in her savings account after x weeks?

- A. $25x + 5$
- B. $5x + 25$
- C. $25(x + 5)$
- D. $5(x + 25)$

Item 9

Technology-Enhanced: 2 points

Select **THREE** expressions that are equivalent to $12x + 8y$.

- A. $12(x + 8y)$
- B. $4(3x + 2y)$
- C. $2(12x + 4y)$
- D. $4(2x + 3y)$
- E. $6x + 6x + 4y + 4y$
- F. $5x + 3x + 3x + x + 6y + y + y$

Item 10

Technology-Enhanced: 2 points

A polygon is graphed on the coordinate grid.

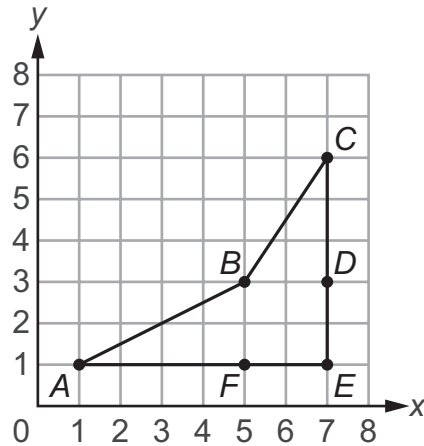

The polygon can be decomposed into two triangles to determine the area of the polygon.

Part A

Which decomposition of two triangles represents the area of the polygon?

- A. the area of triangle ABF plus the area of triangle BCD
- B. the area of triangle ABE plus the area of triangle BCE
- C. the area of triangle ADE plus the area of triangle CFE
- D. the area of triangle ABE plus the area of triangle CFE

Part B

What is the area, in square units, of the polygon?

- A. 10
- B. 11
- C. 12
- D. 13

Item 11

Technology-Enhanced: 2 points

Part A

A metal rod is placed into the ground. The height of the rod above the ground is 100 feet. The depth of the rod is 20 feet in the ground.

What does 0 feet represent in this situation?

- A. The middle of the metal rod.
- B. The top end of the metal rod.
- C. The bottom end of the metal rod.
- D. The point at which the metal rod enters the ground.

Part B

Select TWO statements that can be represented by -40 feet.

- A. The length of a sailboat.
- B. The length of a piece of ribbon.
- C. The change in altitude of a balloon.
- D. The distance of a tree branch above the ground.
- E. The distance of a fish below the surface of the water.

MATHEMATICS ADDITIONAL SAMPLE ITEM KEYS

Item	Standard/ Element	DOK Level	Correct Answer	Explanation
1	MGSE6.NS.4	2	B	The correct answer is choice (B) $5(5 + 9)$. A common factor of 25 and 45 is 5. $\frac{25}{5} = 5$ and $\frac{45}{5} = 9$. So, $25 + 45 = 5(5 + 9)$. Choices (A) and (D) are incorrect because they only factor one of the two terms. Choice (C) is incorrect because it is the result of subtracting 5 from each term instead of dividing by 5.
2	MGSE6.NS.7a	2	A	The correct answer is choice (A) $-1 > -4$ because -1 is to the right of -4 on a horizontal number line oriented left to right. Numbers increase in value moving from left to right along the number line. Since -1 is to the right of -4 on the number line, $-1 > -4$. Choices (B), (C), and (D) are incorrect because the location of the numbers was confused, the sign of the numbers was not considered, and the relative positions of the numbers on the number line was misstated.
3	MGSE6.G.1	2	B	The correct answer is choice (B) 171 ft^2 . The area of the smaller rectangle is $3 \times 9 = 27$ square feet. The area of the larger rectangle is $10 \times 12 = 120$ square feet. The area of the triangle is $\left(\frac{1}{2}\right)(12 \times 4) = 24$ square feet. The total area is $27 + 120 + 24 = 171$ square feet. Choice (A) is incorrect because it uses a width of 9 feet for the larger rectangle instead of 12 feet. Choice (C) is incorrect because it combines the two rectangles into one rectangle with dimensions 12 feet by 13 feet. Choice (D) is incorrect because it uses 4×12 as the area of the triangle instead of $\left(\frac{1}{2}\right)(12 \times 4)$.
4	MGSE6.G.4	2	D	The correct answer is choice (D) 124. The net is comprised of two rectangles each measuring 8×6 inches, two rectangles each measuring 1×8 inches, and two rectangles each measuring 1×6 inches. The total area is $2(8 \times 6) + 2(1 \times 8) + 2(1 \times 6) = 124$ square inches. Choices (A), (B), and (C) are incorrect because they do not include all of the faces of the net.

Item	Standard/ Element	DOK Level	Correct Answer	Explanation
5	MGSE6.G.2	2	D	The correct answer is choice (D) 60. Along the length of the box, 5 cubes will fit. Along the width, 3 cubes will fit. Therefore, 15 cubes will fill the base. The box will hold 4 layers of cubes. That makes the total number of cubes 60. Choices (A) and (B) are incorrect because they are based on the base holding 2 x 1 cubes and there being only 2 layers of cubes. Choice (B) then adds 1 more cube to account for the $\frac{1}{2}$ in the given length and width of the box. Choice (C) is incorrect because it is based on the box holding 4 x 2 cubes in the base or 32 cubes instead of 15.
6	MGSE6.SP.2	1	D	The correct answer is choice (D) The ages of the children ranged from 1 year to 10 years. The least number on the number line with Xs above it is 1. The greatest number on the number line with Xs above it is 10. The data values range from 1 to 10. Choices (A) and (B) are incorrect because they are statements about measures of center instead of a measure of spread. Choice (C) is incorrect because it assumes the spread of the data is the number of ages with Xs above them.
7	MGSE6.EE.5	2	D	The correct answer is choice (D) 11, 13, 22. The values of y that will make the inequality true are the values of y for which 3y is greater than 27. $3(11) = 33$; $3(13) = 39$; $3(22) = 66$. Choices (A) and (B) are incorrect because at least one value of y makes 3y less than 27. Choice (C) is incorrect because when y is 9, 3y is equal to 27.
8	MGSE6.EE.6	2	B	The correct answer is (B) $5x + 25$. Harriet starts with \$25, so the expression must have a value of 25 when $x = 0$. Each week, Harriet adds \$5, so the rate of change is \$5 per week. Choice (A) is incorrect because it interchanges the starting amount with the amount added each week. Choices (C) and (D) use the distributive property incorrectly for this situation.
9	GSE-1: 6.EE.3	2	B/D/E	See scoring rubric on page 74.
10	GSE-1: 6.G.1	3	Part A: B Part B: B	See scoring rubric on page 75.
11	GSE-1: 6.NS.5	2	Part A: D Part B: C, E	See scoring rubric on page 76.
12	MGSE6.NS.1	2	N/A	See scoring rubric and exemplar responses on page 77.

Item	Standard/ Element	DOK Level	Correct Answer	Explanation
13	MGSE6.RP.3b	3	N/A	See scoring rubric and exemplar responses beginning on page 78.

MATHEMATICS EXAMPLE SCORING RUBRICS AND EXEMPLAR RESPONSES

Item 9

Scoring Rubric

Points	Description
2	<p>The response achieves the following:</p> <ul style="list-style-type: none"> • A score of 2 indicates complete understanding of how apply the properties of operations to generate equivalent expressions. • The student selects Choice (B), Choice (E), and Choice (F).
1	<p>The response achieves the following:</p> <ul style="list-style-type: none"> • A score of 1 indicates a partial understanding of how to apply the properties of operations to generate equivalent expressions. • The student selects Choice (B) and Choice (E), with or without an additional incorrect answer. OR • The student selects Choice (B) and Choice (F), with or without an additional incorrect answer. OR • The student selects Choice (E) and Choice (F), with or without an additional incorrect answer.
0	<p>The response achieves the following:</p> <ul style="list-style-type: none"> • A score of 0 indicates limited to no understanding of how to apply the properties of operations to generate equivalent expressions. • The student selects Choice (B), with or without any additional incorrect answers. OR • The student selects Choice (E), with or without any additional incorrect answers. OR • The student selects Choice (F), with or without any additional incorrect answers. OR • The student does not select any correct answers.

Item 10

Scoring Rubric

Points	Description
2	<p>The response achieves the following:</p> <ul style="list-style-type: none"> • A score of 2 indicates complete understanding of how to find area of right triangles, other triangles, quadrilaterals, and polygons by composing into rectangles or decomposing into triangles and other shapes; apply these techniques in the context of solving real-world and mathematical problems. • The student determines that the correct answer for Part A is Choice (B). AND • The student determines that the correct answer for Part B is Choice (B).
1	<p>The response achieves the following:</p> <ul style="list-style-type: none"> • A score of 1 indicates a partial understanding of how to find area of right triangles, other triangles, quadrilaterals, and polygons by composing into rectangles or decomposing into triangles and other shapes; apply these techniques in the context of solving real-world and mathematical problems. • The student determines that the correct answer for Part A is Choice (B). OR • The student determines that the correct answer for Part B is Choice (B).
0	<p>The response achieves the following:</p> <ul style="list-style-type: none"> • A score of 0 indicates limited to no understanding of how to find area of right triangles, other triangles, quadrilaterals, and polygons by composing into rectangles or decomposing into triangles and other shapes; apply these techniques in the context of solving real-world and mathematical problems.

Item 11

Scoring Rubric

Points	Description
2	<p>The response achieves the following:</p> <ul style="list-style-type: none"> A score of 2 indicates complete understanding that positive and negative numbers are used together to describe quantities having opposite directions or values (e.g., temperature above/below zero, elevation above/below sea level, debits/credits, positive/negative electric charge); use positive and negative numbers to represent quantities in real-world contexts, explaining the meaning of 0 in each situation. The student determines that the correct answer for Part A is Choice (D). AND The student determines that the correct answers for Part B are Choice (C) and Choice (E).
1	<p>The response achieves the following:</p> <ul style="list-style-type: none"> A score of 1 indicates a partial understanding that positive and negative numbers are used together to describe quantities having opposite directions or values (e.g., temperature above/below zero, elevation above/below sea level, debits/credits, positive/negative electric charge); use positive and negative numbers to represent quantities in real-world contexts, explaining the meaning of 0 in each situation. The student determines that the correct answer for Part A is Choice (D). OR The student determines that the correct answers for Part B are Choice (C) and Choice (E).
0	<p>The response achieves the following:</p> <ul style="list-style-type: none"> A score of 0 indicates limited to no understanding that positive and negative numbers are used together to describe quantities having opposite directions or values (e.g., temperature above/below zero, elevation above/below sea level, debits/credits, positive/negative electric charge); use positive and negative numbers to represent quantities in real-world contexts, explaining the meaning of 0 in each situation.

Item 12

Scoring Rubric

Points	Description
2	<p>The response achieves the following:</p> <ul style="list-style-type: none"> The response demonstrates a complete understanding of interpreting and computing quotients of fractions and solving word problems involving division of fractions by fractions. Give 2 points for a correct process AND the correct answer. <ul style="list-style-type: none"> Response is correct and complete. Response shows application of a reasonable and relevant strategy. Mathematical ideas are expressed coherently through a complete, logical, and fully developed response using words, calculations, and/or symbols as appropriate.
1	<p>The response achieves the following:</p> <ul style="list-style-type: none"> The response demonstrates a partial understanding of interpreting and computing quotients of fractions and solving word problems involving division of fractions by fractions. Give 1 point for a correct process OR a correct answer with no work shown. <ul style="list-style-type: none"> Response is only partially correct. Response shows application of a relevant strategy, though it may be only partially applied or remain unexplained. Mathematical ideas are expressed only partially using words, calculations, and/or symbols as appropriate.
0	<p>The response achieves the following:</p> <ul style="list-style-type: none"> The response demonstrates no understanding of interpreting and computing quotients of fractions and solving word problems involving division of fractions by fractions. <ul style="list-style-type: none"> Response shows no application of a strategy or application of an irrelevant strategy. Mathematical ideas cannot be interpreted or lack sufficient evidence to support even a limited understanding.

Exemplar Response

Points Awarded	Sample Response
2	$\frac{2}{3} \div \frac{1}{6} = \frac{2}{3} \times \frac{2}{1} = \frac{4}{3} = 1\frac{1}{3}$ <p>4 batches</p>
1	4 batches
0	Response is irrelevant, inappropriate, or not provided.

Item 13

Scoring Rubric

Points	Description
4	<p>The response achieves the following:</p> <ul style="list-style-type: none"> • The response demonstrates a complete understanding of using ratio and rate reasoning to solve real-world and mathematical problems. • Give 4 points for Part A and Part B and Part C completely correct. <ul style="list-style-type: none"> • Response is correct and complete. • Response shows application of a reasonable and relevant strategy. • Mathematical ideas are expressed coherently through a clear, complete, logical, and fully developed response using words, calculations, and/or symbols as appropriate.
3	<p>The response achieves the following:</p> <ul style="list-style-type: none"> • The response demonstrates a good understanding of using ratio and rate reasoning to solve real-world and mathematical problems. • Give 3 points for Part A and Part B correct and Part C partially correct OR Part A or Part B correct and Part C correct based on an error in a previous part. <ul style="list-style-type: none"> • Response is mostly correct, but contains either a computation error or an unclear or incomplete explanation. • Response shows application of a relevant strategy, though it may be only partially applied or remain unexplained. • Mathematical ideas are expressed only partially using words, calculations, and/or symbols as appropriate.
2	<p>The response achieves the following:</p> <ul style="list-style-type: none"> • The response demonstrates a partial understanding of using ratio and rate reasoning to solve real-world and mathematical problems. • Give 2 points for Part A and Part B correct OR for Part C correct based on incorrect answers given in Part A and Part B. <ul style="list-style-type: none"> • Response is only partially correct. • Response shows application of a relevant strategy, though it may be only partially applied or remain unexplained. • Mathematical ideas are expressed only partially using words, calculations, and/or symbols as appropriate.
1	<p>The response achieves the following:</p> <ul style="list-style-type: none"> • The response demonstrates a limited understanding of using ratio and rate reasoning to solve real-world and mathematical problems. • Give 1 point for Part A correct OR Part B correct OR Part C partially correct. <ul style="list-style-type: none"> • Response is only partially correct. • Response shows incomplete or inaccurate application of a relevant strategy. • Mathematical ideas are expressed only partially using words, calculations, and/or symbols as appropriate.

Points	Description
0	<p>The response achieves the following:</p> <ul style="list-style-type: none"> • The response demonstrates no understanding of using ratio and rate reasoning to solve real-world and mathematical problems. <ul style="list-style-type: none"> • Response shows no application of a strategy. • Mathematical ideas cannot be interpreted or lack sufficient evidence to support even a limited understanding.

Exemplar Response

Points Awarded	Sample Response
4	Part A: \$0.42 Part B: \$2.70 Part C: By shopping at Gary's Gardens, Kate will save \$0.36. AND The difference in cost per pound at the two places is \$0.03 per pound times 12 pounds, which is \$0.36. OR other valid response
3	Part A: \$0.42 Part B: \$2.70 Part C: \$0.36 OR other valid response
2	Part A: \$0.42 Part B: \$2.70
1	Part A: \$0.42
0	Response is irrelevant, inappropriate, or not provided.

APPENDIX A: LANGUAGE PROGRESSIVE SKILLS, BY GRADE

The following skills, marked with an asterisk (*) in Language standards 1–3, are particularly likely to require continued attention in higher grades as they are applied to increasingly sophisticated writing and speaking.

Standard	Grade(s)							
	3	4	5	6	7	8	9–10	11–12
L.3.1f. Ensure subject-verb and pronoun-antecedent agreement.								
L.3.3a. Choose words and phrases for effect.								
L.4.1f. Produce complete sentences, recognizing and correcting inappropriate fragments and run-ons.								
L.4.1g. Correctly use frequently confused words (e.g., <i>to/too/two; there/their</i>).								
L.4.3a. Choose words and phrases to convey ideas precisely.*								
L.4.3b. Choose punctuation for effect.								
L.5.1d. Recognize and correct inappropriate shifts in verb tense.								
L.5.2a. Use punctuation to separate items in a series.†								
L.6.1c. Recognize and correct inappropriate shifts in pronoun number and person.								
L.6.1d. Recognize and correct vague pronouns (i.e., ones with unclear or ambiguous antecedents).								
L.6.1e. Recognize variations from standard English in their own and others' writing and speaking, and identify and use strategies to improve expression in conventional language.								
L.6.2a. Use punctuation (commas, parentheses, dashes) to set off nonrestrictive/parenthetical elements.								
L.6.3a. Vary sentence patterns for meaning, reader/listener interest, and style.*								
L.6.3b. Maintain consistency in style and tone.								
L.7.1c. Places phrases and clauses within a sentence, recognizing and correcting misplaced and dangling modifiers.								
L.7.3a. Choose language that expresses ideas precisely and concisely, recognizing and eliminating wordiness and redundancy.								
L.8.1d. Recognize and correct inappropriate shifts in verb voice and mood.								
L.9-10.1a. Use parallel structure.								

* Subsumed by L.7.3a

† Subsumed by L.9-10.1a

‡ Subsumed by L.11-12.3a

APPENDIX B: CONDITION CODES

Condition Codes (Non-Score)

The student response is flawed for various reasons and will receive a condition code (non-score).

Students who receive a condition code (non-score) have a score of zero (0).

- For the extended writing tasks, both traits receive a score of 0. For Trait 1: Ideas, the score is 0 out of 4 possible points, and for Trait 2: Language Usage, the score is 0 out of 3 points. (Or the score is 0 points out of a possible 7 points.)
- For the narrative item, the score is 0 out of a possible 4 points.

Non-Score (Code)	Performance Scoring: Non-Score (Code) Description	Full Description
B	Blank	<ul style="list-style-type: none"> • Blank • Student's response did not contain words. • In some instances, student may have drawn pictures.
C	Copied	<ul style="list-style-type: none"> • Student's response is not his/her own work. • Student does not clearly attribute words to the text(s). • Student copies from the text(s) that serve(s) as writing stimulus.
I	Too Limited to Score	<ul style="list-style-type: none"> • Student's response is not long enough to evaluate his/her ability to write to genre or his/her command of language conventions.
F	Non-English/ Foreign Language	<ul style="list-style-type: none"> • Written in some language other than English • The writing items/tasks on the test require the student to write in English.
T	Off Topic/Off Task	<ul style="list-style-type: none"> • Student may have written something that is totally off topic (e.g., major portion of response is unrelated to the assigned task). • Student response did not follow the directions of the assigned task (i.e., off task).
U	Unreadable/ Illegible/ Incomprehensible	<ul style="list-style-type: none"> • Response is unreadable. • An illegible response does not contain enough recognizable words to provide a score. • An incomprehensible paper contains few recognizable English words, or it may contain recognizable English words arranged in such a way that no meaning is conveyed.
S	Offensive	<ul style="list-style-type: none"> • Student uses inappropriate or offensive language or pictures.

Assessment Guide
Grade 6
End-of-Grade

